

# *eclipse<sup>®</sup><sub>dx</sub>*

## *Instruction and Reference Guide*

Model BLE1DX-2



**FOR THE LOVE OF SEWING**

---

To register your machine warranty and receive Baby Lock product updates and offers, go to [www.babylock.com/profile](http://www.babylock.com/profile). If you have questions with registration, visit your Authorized Baby Lock Retailer.

Baby Lock Consumer Helpline: 800-313-4110

[www.babylock.com](http://www.babylock.com)

# "IMPORTANT SAFETY INSTRUCTIONS"

When using overlock machine, basic safety precautions should always be followed, including the following.

"Read all instructions before using this overlock machine."

## **DANGER-** To reduce the risk of electric shock.

1. The overlock machine should never be left unattended when plugged in. Always unplug this overlock machine from the electrical outlet immediately after using and before cleaning.
2. Always unplug before replacing light bulb. Replace bulb with same type rated 15 watts/110 volts in 110V/120V area. (15 watts 230 volts in 220V/240V area.)

## **WARNING-** To reduce the risk of burns, fire, electric shock, or injury to persons.

1. Do not allow to be used as a toy. Close attention is necessary when the sewing machine is used by or near children.
2. Use this overlock machine only for its intended use as described in this manual. Use only attachments recommended by the manufacturer as contained in this manual.
3. Never operate this overlock machine if it has a damaged cord or plug, if it is not working properly, if it has been dropped or damaged, or dropped into water. Return the overlock machine to the nearest authorized retailer or service center for examination, repair, electrical or mechanical adjustment.
4. Never operate the overlock machine with any air openings blocked. Keep ventilation openings of the overlock machine and foot controller free from the accumulation of lint, dust, and loose cloth.
5. Never drop or insert any object into any opening.
6. Do not use outdoors.
7. Do not operate where aerosol (spray) products are being used or where oxygen is being administered.
8. To disconnect, turn the main switch to the symbol "O" position which represents off, then remove plug from outlet.
9. Do not unplug by pulling on cord. To unplug, grasp the plug, not the cord.
10. Keep fingers away from all moving parts. Special care is required around the overlock machine needle.
11. Always use the proper needle plate. The wrong needle plate can cause the needle to break.
12. Do not use bent needles.
13. Do not pull or push fabric while stitching. It may deflect the needle(s) causing it to break.
14. Switch the overlock machine to the symbol "O" position when making any adjustments in the needle area, such as threading needle, changing needle, threading looper, or changing presser foot, and the like.
15. Always unplug the overlock machine from the electrical outlet when removing covers, lubricating, or when making any of the user servicing adjustments mentioned in the instruction manual.
16. Keep fingers away from moving parts, especially the area near the blades.
17. Please note that on disposal, this product must be safely recycled in accordance with relevant National legislation relating to electrical / electronic products. If in doubt, please contact your retailer for guidance.
18. The appliance is not intended for use by young children or infirm persons without supervision.
19. Young children should be supervised to ensure that they do not play with the appliance.



**"SAVE THESE INSTRUCTIONS"**

**"This overlock machine is intended for household use."**

## ***Congratulations on Choosing Baby Lock Eclipse dx***

You are now entering an exciting new era in sewing. As a Baby Lock Eclipse owner, you are opening the door to more creative sewing adventures *and* a new ease in serger sewing.

You'll be able to duplicate professional seaming and finishing as seen in even the most expensive ready-to-wear. Because of the serger's high-speed capability — up to 1,500 stitches per minute — and its ability to seam, overcast and trim, all in one operation, you will be completing more projects in less time. Fabrics and handling techniques you previously avoided will no longer pose a challenge—the Baby Lock Eclipse handles all types of fabrics with equal ease. And, because of the way it forms stitches, your serger can accommodate a larger variety of threads than conventional machines, inspiring endless decorative options, too. And those threads will be easier than ever to thread, thanks to the Eclipse's revolutionary new “Instant Jet-Air Threading System”!

Your Baby Lock Eclipse is a high-quality, dependable performance machine. With proper care and maintenance, it will give you many years of sewing pleasure. We suggest you follow your instruction manual as a step-by-step guide to acquainting you with serger sewing. Later, as you become more confident, the manual will become a handy reference for expanding your abilities.



# Table of Contents

<b>OVERVIEW</b> .....	4
How Your Serger Operates .....	4
Overview Of The Eclipse .....	5
<b>ACCESSORIES</b> .....	6
Needles .....	7
Thread.....	7
Optional Accessories .....	7
<b>SERGER SET UP</b> .....	8
Threading Preparation .....	9
Threading Your Eclipse .....	10
Locked Position for Threading .....	10
Lower Looper .....	10
Upper Looper .....	11
Right Needle .....	12
Left Needle .....	13
Unlocked Position for Serging .....	13
<b>SERGING WITH FABRIC</b> .....	14
Clearing the Stitch Fingers .....	14
Tension Adjustment .....	15
Rethreading Loopers .....	15
Rethreading Needles .....	15
<b>ECLIPSE MACHINE SETTINGS</b> .....	16
Stitch Length/Rolled Hem.....	16
Stitch Width .....	16
Differential Feed .....	17
Disengaging the Upper Cutting Blade .....	18
Presser Foot Pressure .....	18
Snap-On Presser Foot .....	18
<b>BASIC SERGING TECHNIQUES</b> .....	19
Overedging .....	19
Seaming .....	19
Front Cover Seam Guide .....	19
Securing Ends .....	20/21
Turning Outside Corners .....	22
Turning Inside Corners .....	22
Serging Curves .....	23
Inserting Tapes .....	23
<b>4-THREAD SERGING</b> .....	24
<b>3-THREAD SERGING</b> .....	25

## Table of Contents (Cont.)

<b>2-THREAD SERGING</b> .....	26
Converting from 3-thread Serging .....	26
Flatlock Seams .....	27
Flatlock “Topstitching” .....	28
Blind Hemming .....	29
Returning to 3- or 4-thread Serging .....	30
<b>ROLLED EDGING</b> .....	31
3-thread Rolled Edge .....	31
Seaming Sheers .....	32
2-Thread Rolled Edge .....	32
Lettuce Edge .....	33
Belt Loops and Button Loops .....	33
Returning to Standard Serging .....	33
<b>USING SPECIALTY THREADS</b> .....	34
Threading Lightweight Thread .....	34
Changing Threads .....	34
Threading Medium Weight Thread .....	35
Thread Cradle .....	35
Looper Threading Tool .....	36
Bypassing the Threading Port .....	37
Specialty Thread Guide Chart .....	38/39
<b>MAINTENANCE</b> .....	40
Replacing Needles .....	40
Replacing Cutting Blades .....	40
Cleaning .....	41
Replacing the Light Bulb .....	41
<b>TROUBLESHOOTING</b> .....	42/43
<b>DO’s and DON’Ts</b> .....	43
<b>TECHNICAL DATA</b> .....	44
<b>CHART FOR TENSION ADJUSTMENT</b> .....	Back Cover

Copyright © 1994 by Tacony Corporation, Fenton, Mo U.S.A.

*This book may not be reprinted or reproduced by any means without written permission from Tacony Corporation.*

## How Your Serger Operates

Sometimes called an overlock machine or overlocker, the serger is different from any conventional sewing machine you have used. Awareness of its simple operation will enable you to become more proficient in its use. Please read all instructions before using your new serger.

Serging is a kind of knitting process that loops two, three or four threads together to create a stitch. Your Baby Lock Eclipse operates with one or two needles and one or two “loopers,” each carrying a thread, that take the place of a bobbin.

When fabric is placed into the machine, it reaches the feed dogs first. The feed dogs move the fabric along as the cutting blades trim the edge, creating a clean edge to be finished. Then the loopers and needle(s) form the stitch on the fabric edge, supported by one or more parallel “stitch fingers” — metal prongs that keep the fabric flat. The threads become “locked” over the fabric and the resulting stitches encase the raw edge with thread to prevent fabric raveling.

After setting up your machine for the first time, take a few moments to learn how it sews. Before your serger is threaded, turn the handwheel — toward you — and watch the movement and operation of the various parts. Don't bother with fabric at first. It doesn't hurt your serger to stitch without fabric under the presser foot.

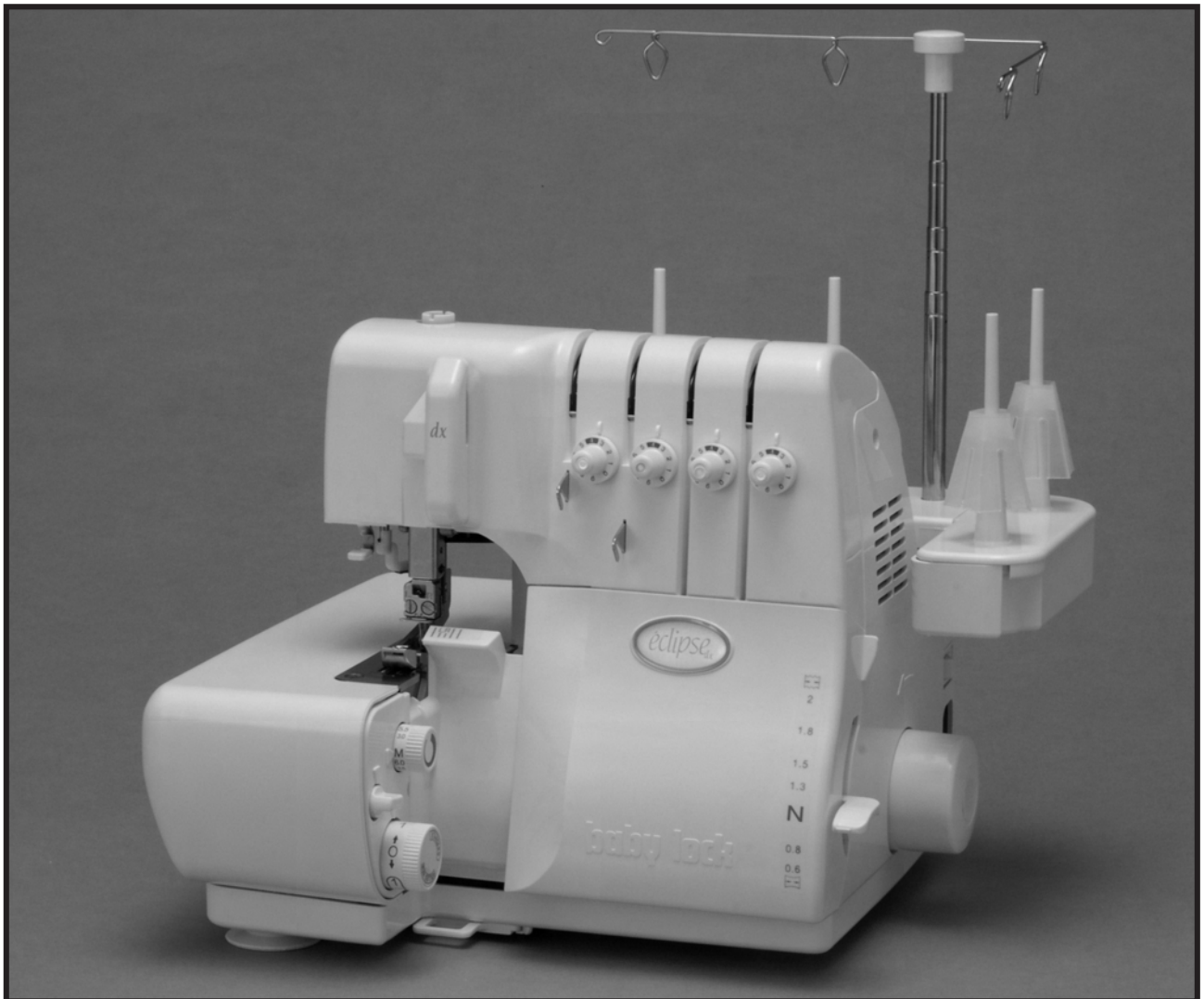

# Overview of the Eclipse

- 1-Needle threader selector
  - 2-Presser foot lifter/tension release lever\*
  - 3-Thread cutter
  - 4-Needle threader lever
  - 5-Needle height viewing area
  - 6-Needle clamp screw
  - 7-Snap-on presser foot
  - 8-Throat plate
  - 9-Stitch width adjusting dial
  - 10-Cutting blade cover fixing screw
  - 11-Cutting blade cover
  - 12-Cutting blade lock switch
  - 13-Stitch length/rolled hem adjusting dial
  - 14-Needle drop drawer
  - 15-Subsidiary looper
  - 16-Front cover
  - 17-Machine lock button release lever
  - 18-Machine lock button
  - 19-Looper threading lever
  - 20-Differential feed adjusting lever
  - 21-Handwheel
  - 22-Lower looper threading port
  - 23-Power switch
  - 24-Looper threader selector
  - 25-Accessory compartment
  - 26-Upper looper threading port
  - 27-Lower looper thread tension adjuster
  - 28-Upper looper thread tension adjuster
  - 29-Carrying handle
  - 30-Right needle thread tension adjuster
  - 31-Telescopic thread guide
  - 32-Left needle thread tension adjuster
  - 33-Presser foot pressure adjusting screw
- \* Raising the presser foot releases all tensions.

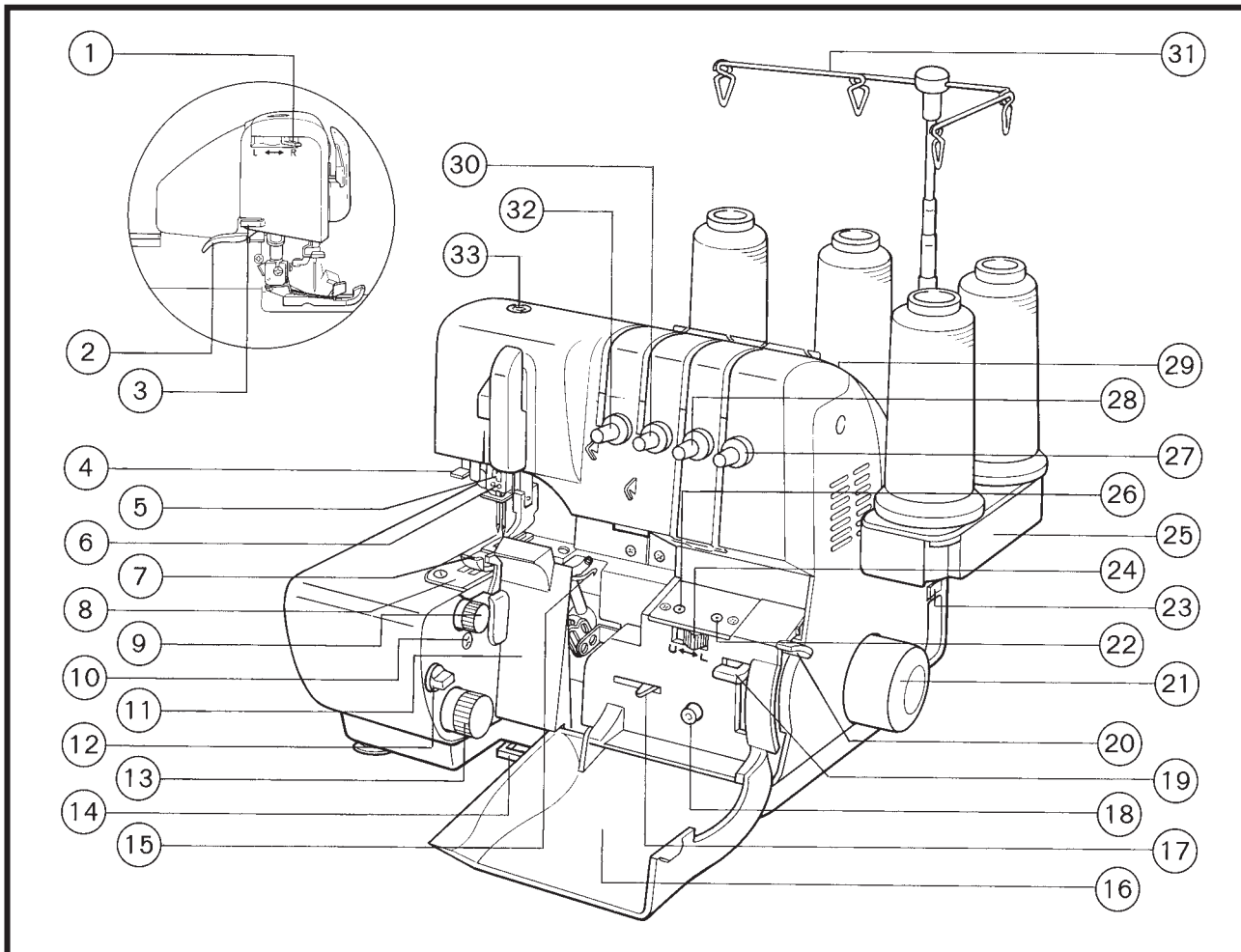



## Accessories

Your Baby Lock Eclipse serger has a built-in accessory compartment, the “lid” of which forms the thread stand for the looper thread cones. To open, swing the “lid” (with or without thread spools atop) to the right to reveal the tray holding some of the accessories listed below. Others may be found in the machine’s packing materials.

Accessory	Number included	Located in
Instruction manual	1	Packing box
Instructional DVD (U.S.A. only)	1	Packing box
Lint brush/needle insert tool	1	Accessory compartment
Needle clamp screw	2	Accessory compartment
Package of assorted sized needles Schmetz or Organ HA x ISP	1	Accessory compartment
Small screwdriver	1	Accessory compartment
Tweezers	1	Accessory compartment
Upper cutting blade for replacement	1	Accessory compartment
Looper threading tool	1	Accessory packet
Screwdriver	1	Accessory packet
Machine cover	1	Accessory packet
Spool caps	4	Accessory packet
Sponge disks	4	Accessory packet
Thread nets	4	Accessory packet
Allen wrench	1	Accessory packet
Cone holders	4	On machine

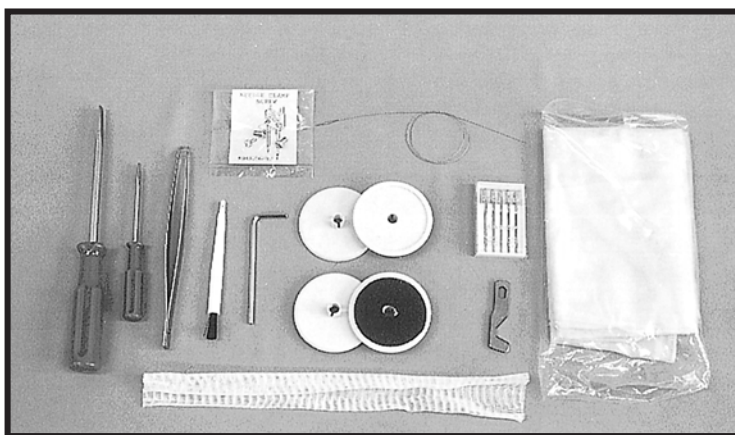
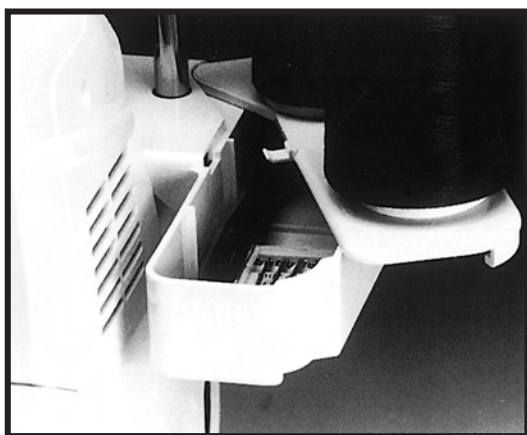



## Needles

Your Baby Lock Eclipse serger is set up with size 75/11 machine needles, which are suitable for most medium and lightweight fabrics. For heavyweight fabrics, change to a universal needle, size 90/14. The needle's semi-ballpoint design is suitable for knits and wovens. Some manufacturers' needles may produce better quality stitches with your Baby Lock than others. For best results, use Schmetz or Organ brand needles - system HAXISP, and replace them approximately every third project (page 40).

## Thread

All types of thread may be used on your Baby Lock, but 100 percent long-staple polyester thread, crosswound on a cone, consistently provides the best stitch performance. Because the threads must pass through several thread guides at high speeds, they must be of uniform thickness and high strength with a minimum amount of linting.

Good-quality cotton or cotton-covered polyester threads sew well, though they produce more lint, creating the need to clean the machine more frequently. They work well for overedging and seaming, but they may be too weak or too fuzzy for the rolled edge. Poor grades of these threads can result in frequent fraying and breaking.

Threads of other fiber contents and weights may be used, depending on their strength and thickness. Testing will help you determine how easily they can pass through the thread guides, tension disks, needles and loopers. Specialty threads often require tension adjustments, too. For more information, (pages 38/39).

## Optional Accessories

There are optional snap-on specialty feet available for the Eclipse. The optional accessories are available at your Baby Lock retailer.

• Beading Foot	R0-B5002-01A-C-E	(BLE-BF)
• Blindhem Foot	R0-B5002S02A-E	(BLE-BLHFS)
• Clear Foot	R0-B5002K01A-E	(BLE-CLF)
• Cording / Piping Foot (3mm)	R0-B5002-02A-C-E	(BLE-CF3)
• Cording / Piping Foot (5mm)	R0-B5002-03A-C-E	(BLE-CF5)
• Elastic Applicator Foot	R0-B5002S01A-E	(BLE-EF)
• Flat Sole Foot	R0-B5001K02B-C-E	(BLE-FSF)
• Lace Applicator Foot	R0-B5002S05A-E	(BLE-LF)
• Ruffling Foot	R0-B5002S03A-E	(BLE-RF)
• Bulb Remover Tool	R0-B7525-01A	(262011)
• Size 90 Top Stitch Needle		(T-90B)

## Setting Up Your Serger

After removing the packing materials from the box, gently lift your Baby Lock serger by grasping the handle provided on the top of the machine. Place the machine on a serger sewing table or any level surface that provides ample work area to the left of the machine. Place the foot control in a pedal stay, if desired, and place it under the sewing table.

Plug the power cord into the machine first, then into a wall outlet. The power switch is located toward the back on the right side of the machine. Always make sure the power is OFF when the machine is not in use (fig.A).

Available foot control for U.S.A.: Model YC-482, or YC-420W

This appliance has a polarized plug (one blade wider than the other). To reduce the risk of electric shock, this plug is intended to fit in a polarized outlet only one way. If the plug does not fit fully in the outlet, reverse the plug. If it still does not fit, contact a qualified electrician to install the proper outlet. Do not modify the plug in any way.

The sewing speed of the machine is determined by the amount of pressure applied to the foot control. When not in use, do not place anything on the foot control, or the machine could start inadvertently and the foot control or motor could burn out (fig.A).

Raise the telescopic thread guide to its highest position of 14". Rotate the shaft to the left and right until each section "clicks" into a locked position (fig.B). The front cover may be opened simply by placing your fingers behind the tab at the right side and pulling toward you (fig.C).

To open the cutting blade cover, place your thumb against the tab, and slide the cover to the right. A slight pull forward will allow the cover to swing down, providing access to the loopers, blades, and thread guides (fig.D).

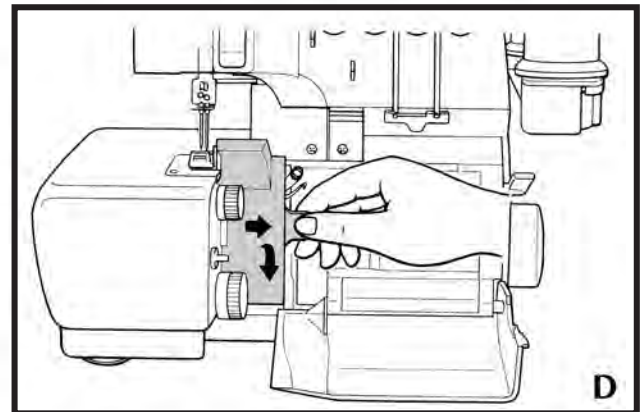
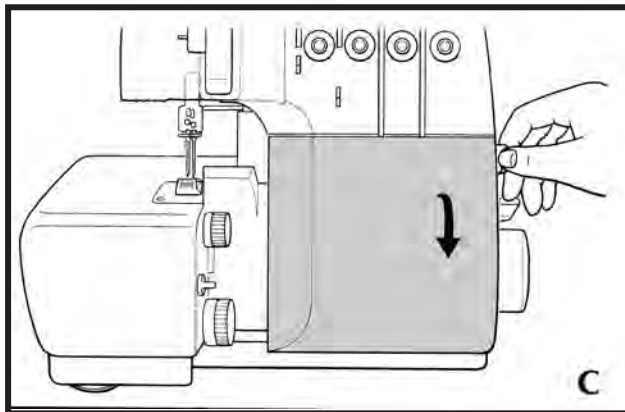
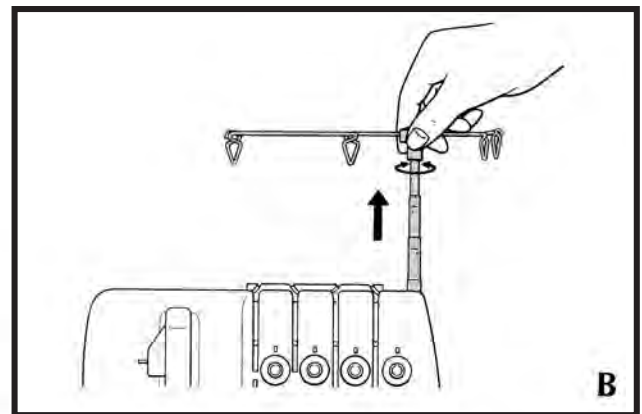
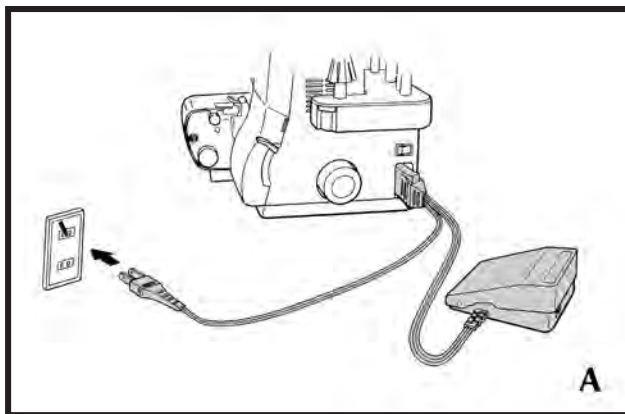

## Threading Preparation

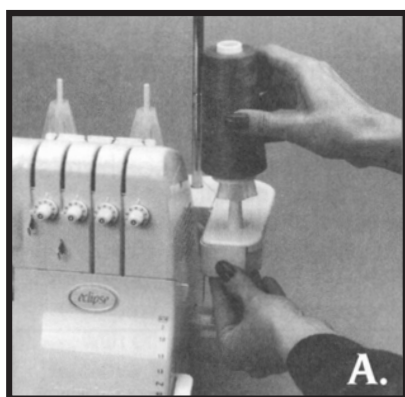

When using threads on cones or king spools place the cone or spool securely over the cone holders furnished on your machine. To avoid bending the thread stand, you may need to place one hand under the stand while positioning the cone. The cone holders prevent the cone or spool from spinning, enabling the thread to feed evenly (fig.A).

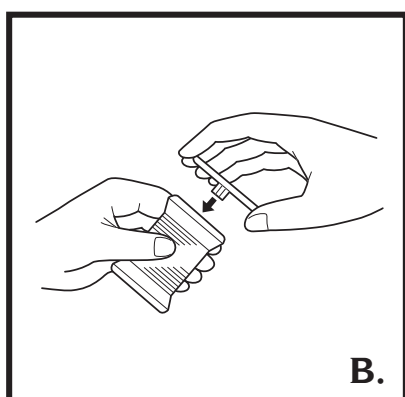

Because threads for the serger feed from the top, standard-spool threads can snag on the rough edges of many of these spools. That's why spool caps are furnished with your Eclipse to provide a smooth surface that enables the thread to reel off freely. With the spool notch side down, insert a spool cap into the top of the spool (fig.B).

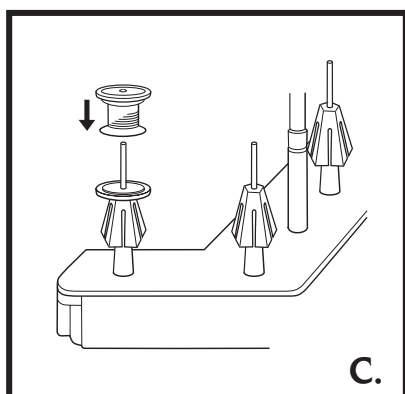

When using standard spool threads on your serger, replace the cone holders with the sponge disks furnished with your machine. These disks hold smaller spools securely and help the thread to reel off properly. With the sponge disk in place, put the capped spool on the spindle (fig.C).

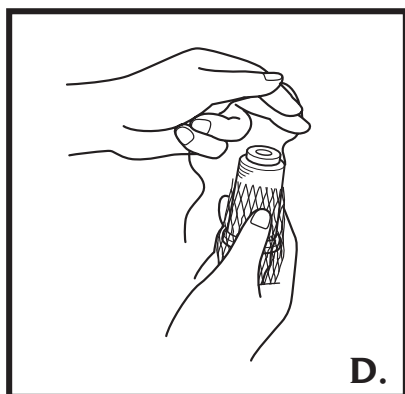

Thread nets may be placed over threads that tend to slip off the bottom of the spool during sewing. Most threads do not require their use, but nets often are necessary with nylon, rayon or silk threads (fig.D). Once it's on the spool, fold the net back on itself, if necessary, to enable the thread to feed smoothly without snagging on the net (fig.E).

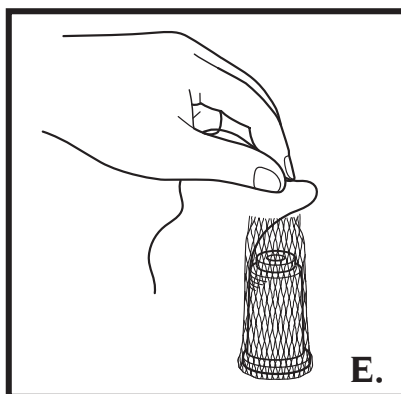

## Threading Your Eclipse

Your Baby Lock Eclipse is equipped with an exclusive “Instant Jet-Air Threading System” for fast, easy threading of the upper and lower looper. One touch of the threading lever inside the front cover instantly and automatically “jet-airs” the thread through tubular loopers. You no longer need your tweezers to thread manually through multiple thread guides, so there’s no more color coding. And threading sequence doesn’t matter either. If a single thread breaks or runs out, you just rethread it without disrupting the others (page 15).

## Locked Position for Threading

1. Open front cover and raise the presser foot to release all tensions.
2. Depress the machine lock button firmly with your left index finger or thumb. At the same time, manually rotate the machine handwheel slowly forward until the button “snaps” into the locked position and the lock button release lever moves to the far left (fig.A)

**Note:** The Eclipse must be in the locked position when threading the loopers and needles, unless otherwise indicated.

## Lower Looper

1. With the presser foot up and machine lock button in the locked position (fig.A), set the looper threader selector lever to “L” for lower looper threading (fig.B).
2. Place the thread cone or spool on the far right front spool pin. Slip the thread into the telescopic antenna thread guide “1” directly above the spool, snap into the thread guide “2” at the top of the machine, through the slot on the front of the machine. (fig.C, page 11)
3. Pull 18 inches (45cm) of thread through guide “3”. Insert the end of the thread into the threading port “L” about 1 inch (2.5cm). Use tweezers if necessary, to insert the thread end more easily.
4. Depress the looper threading lever (fig.D, page 11). If the thread does not go through the lower looper eye with one push, depress the threading lever again until it does.
5. Clip the thread 4 inches (10cm) from the lower looper eye and leave it hanging loose.
6. Move the lock button release lever to the right.

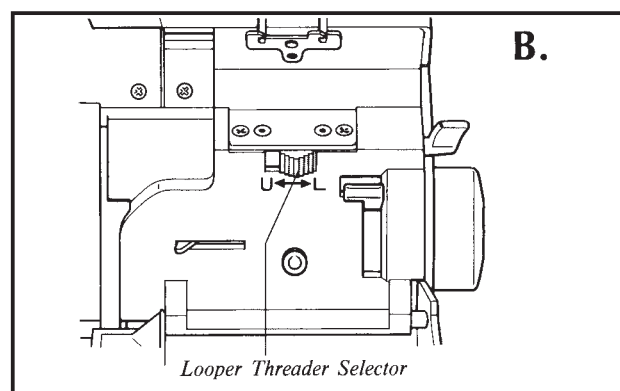
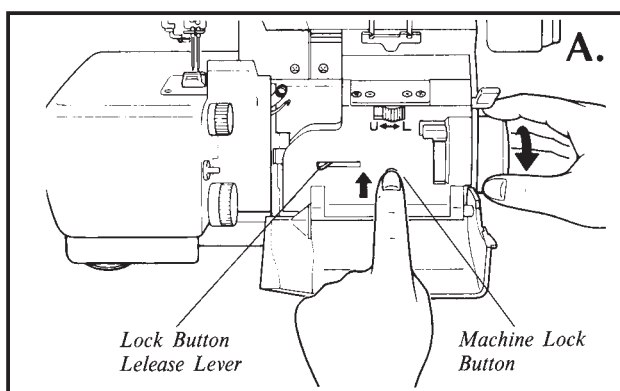

## Upper Looper

1. With the presser foot up and machine lock button in the locked position (fig.A, page 10), set the looper threader selector lever to "U" for upper looper threading. (fig.B, page 10)
2. Place the thread cone or spool on the second spool pin from the right back. Slip the thread into the telescopic antenna thread guide "A" directly above the spool, snap into the thread guide "B" at the top of the front of the machine, through the slot on the front cover. (fig.C, below)
3. Pull 18 inches (45cm) of thread through guide "C". Insert the end of the thread into the threading port "U", about 1 inch (2.5cm). Use tweezers, if necessary, to insert the thread end more easily. (fig.D below)
4. Depress the looper threader lever (fig.D below). If the thread does not go through the upper looper eye with one push, depress the looper threader lever again until it does, and leave thread hanging loose.
5. Move the lock button release lever to the right, to unlock the machine.

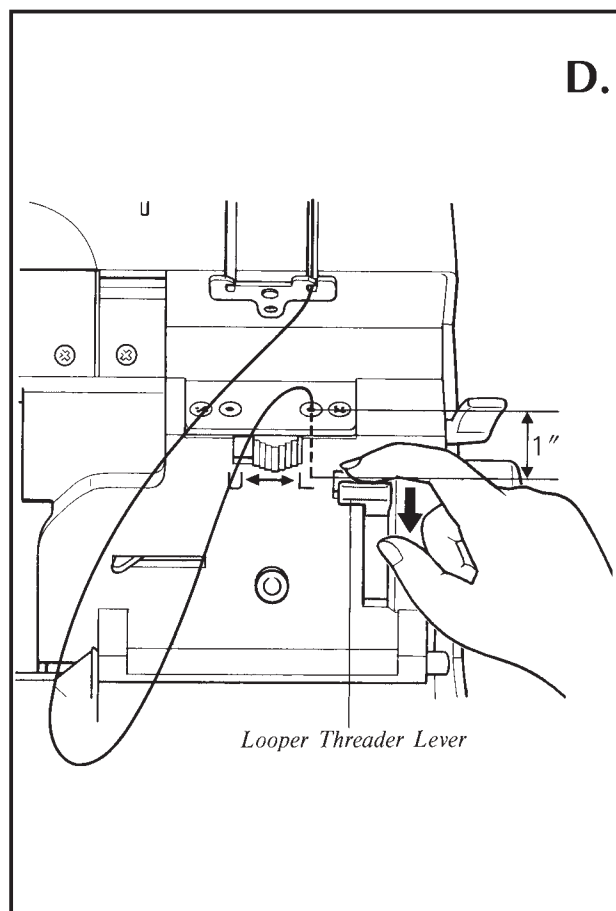
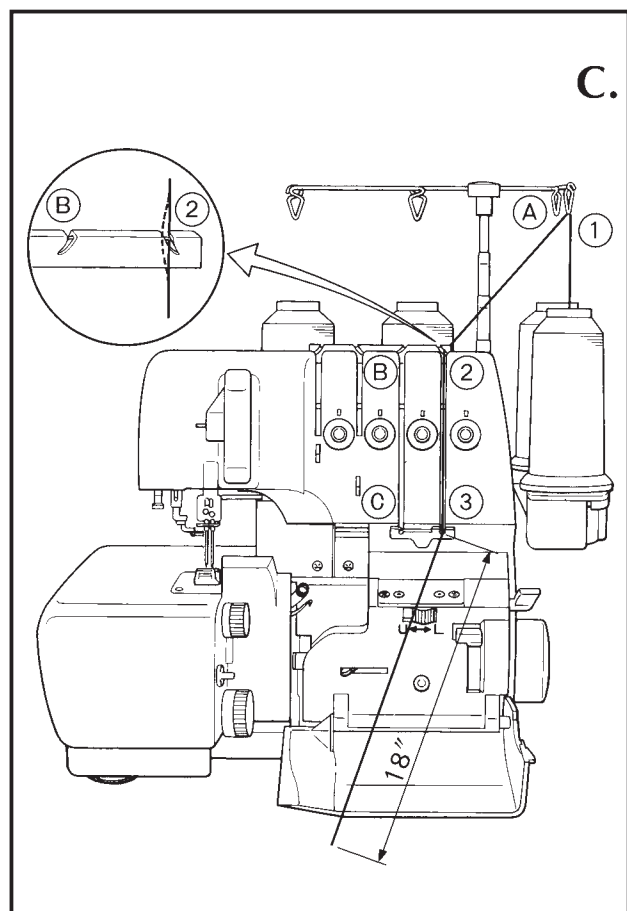

\*Be sure at least 1" of thread is inserted into the threading port.

## Right Needle

1. With the presser foot up and the lock button in the locked position (page 10), set the needle threader selector on "R" for *right* needle (fig.B page 13).  
**Note:** Be sure to push the needle threader selector all the way to R.
2. Place the thread on the second from left spindle on the thread stand (fig.A). Thread needle thread guides ① and ②, through the groove on the face plate and through guides ③, ④, ⑤ and ⑥. Pull a 6 inch length of thread through guide ⑥.
3. Lower the presser foot to engage the tensions.
4. Hold the thread between your left thumb and middle finger (fig.B page 13). With your right index finger, hold the thread horizontally in front and just below the needle eye. With the left index finger, push the needle threader lever down to insert the hook into the needle eye. Slip the thread into the threader hook guides in front of the needle. Carefully release the needle threader lever and remove your right index finger, allowing the thread to be pulled through the needle eye.
5. Continue pulling the thread loop manually through the needle eye until a single strand is threaded. Place the thread under the presser foot and to the left.

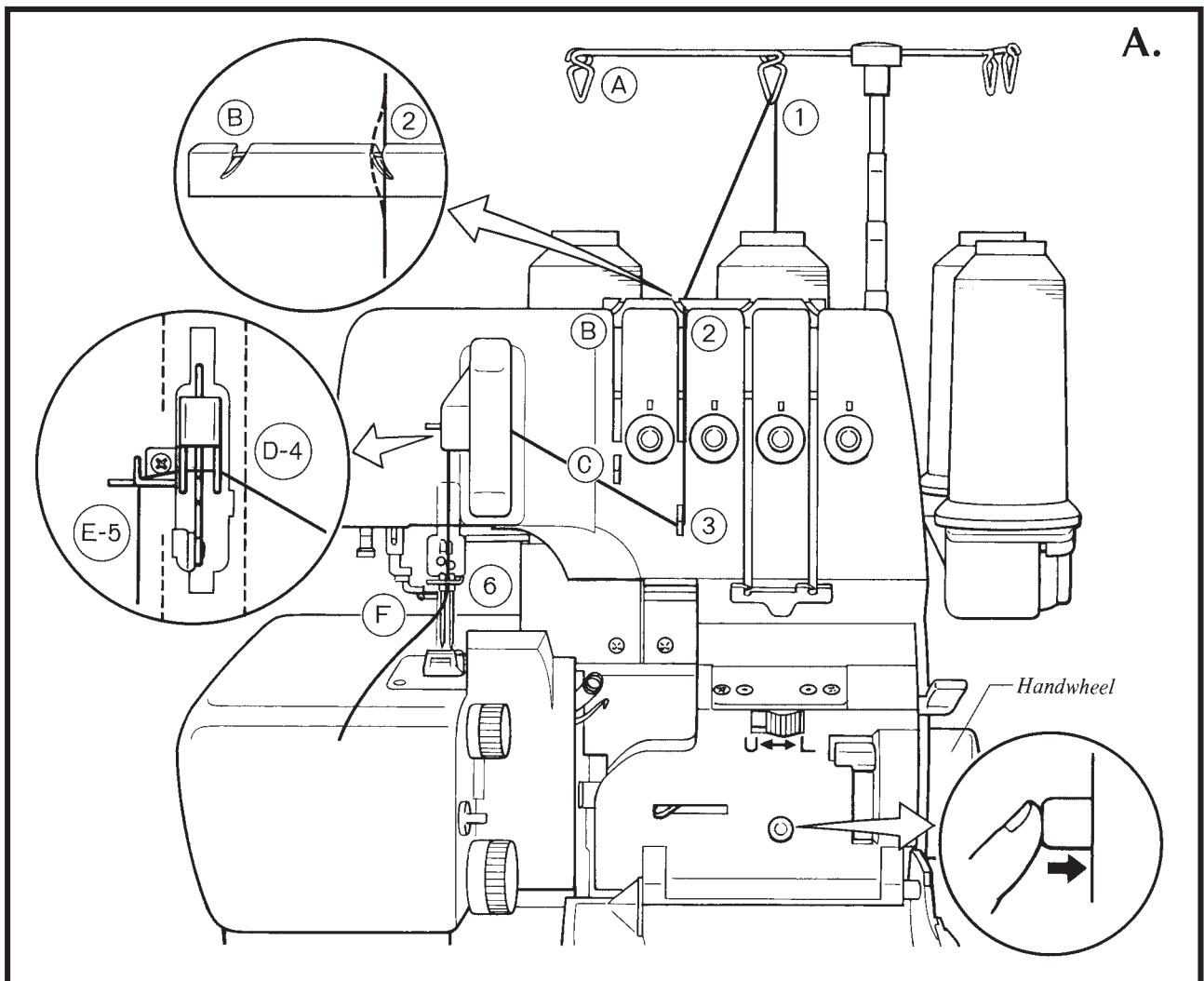



## Left Needle

1. With the machine lock button in the locked position, set the needle threader selector on "L" for *left* needle.
2. Place the thread on the far-left spindle on the thread stand (fig.A page 12). Thread needle thread guides (A) and (B), through the groove the groove on the face plate and through guides (C), (D), (E), and (F). Pull a 6" length of thread from guide (F).
3. Lower the presser foot and thread the left needle as in steps 4 and 5, under "Right Needle."

## Unlocked Position for Serging

After threading is complete, move the lock button release lever to the right until it stops. You will hear the lock release as the lock button pops out automatically (fig.C). Close the front cover.

**Note:** If the lock button is not released, the machine will not run, even if you operate the foot controller.

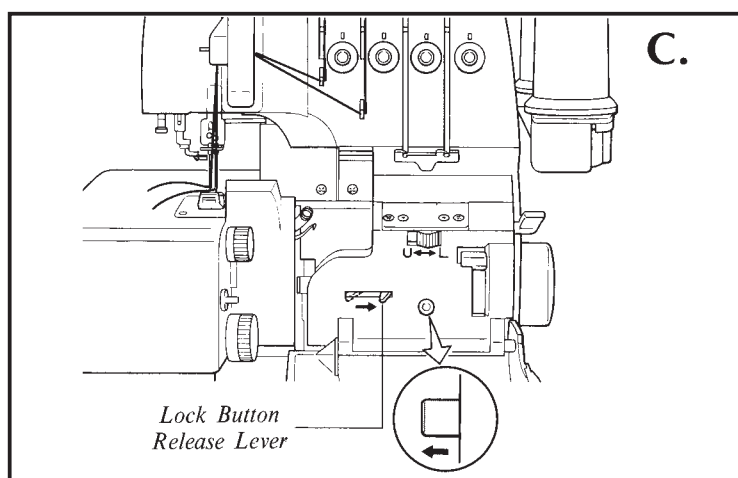
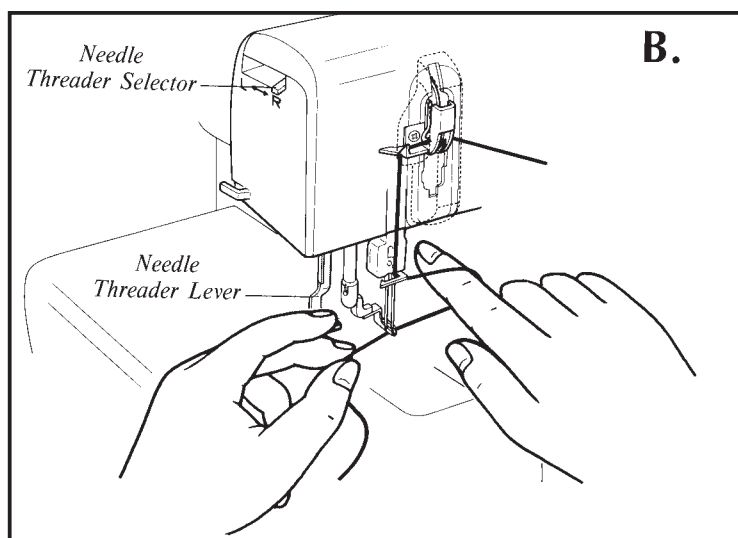

## *Serging with Fabric*

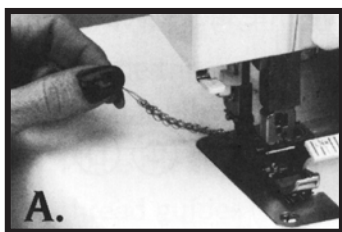

With the needle and upper looper threads under the foot and to the back, lower the presser foot. While holding the threads in your left hand, press down on the foot controller gently to begin a thread chain before serging fabric (fig.A)

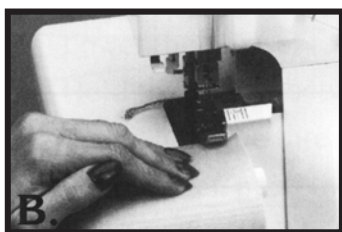

You can leave the presser foot down for most serging applications. Just place the fabric at the toe of the presser foot. As you step on the foot controller, the feed dogs will begin moving the fabric toward the needle (fig.B). You need to raise and lower the foot only when working with thick, spongy or lofty fabrics, or when precise positioning is required.

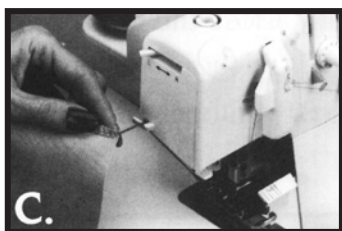

Be careful not to push or pull the fabric. The Eclipse will feed it evenly without help. At the end of a seam, just sew off the fabric edge and continue serging to create a 5" - 6" thread chain. Cut the thread chain with the thread cutter on the left side cover (fig.C)

## *Clearing the Stitch Fingers*

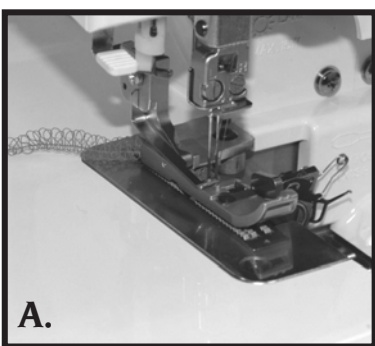

As you serge, you will discover that maneuvering the fabric is different from conventional sewing because the threads form around the stitch fingers (fig.A)

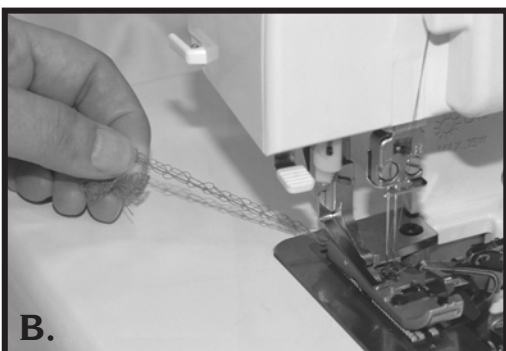

To clear the stitch fingers, simply raise the presser foot, which release all tensions, and raise the needle (fig.B). Then pull the threads gently from behind the foot. The stitches are now released from the fingers (fig.C)



## ***Tension Adjustment***

Your Baby Lock's thread tension is preset at the factory for standard thread and fabric. But the tensions will require adjustment at times, depending on the thread and fabric being used and the stitch to be formed. Refer to the tension chart on the inside back cover. Also, study the diagrams that accompany the explanation of each stitch type. For best results, always sew a test sample before beginning to serge on the actual project.

## ***Rethreading Loopers***

If a thread breaks, raise the presser foot and pull the broken thread out from under the foot. Open the front cover, lock the machine lock button and set the looper threader selector to "U" or "L" for the looper being threaded. Rethread the machine above the threading port, leaving an 18 inch thread tail. Thread the looper as usual. Close the front cover and run a test sample.

**Note:** When rethreading your Baby Lock Eclipse using the "Jet-Air Threading" feature, make certain that the previous thread that was in the tubes is completely removed from the tip of looper. This will eliminate any chance of the previous thread obstructing the flow of the air when **rethreading the machine**.

## ***Rethreading Needles***

If a needle thread breaks, raise the presser foot and needles to the highest position. Remove the broken thread and rethread the needle thread guides. Select the "R" or "L" for the needle being rethreaded. Use the needle threader for exact easier threading. Refer to (pages 12/13) for further information.

## Stitch length/Rolled Hem

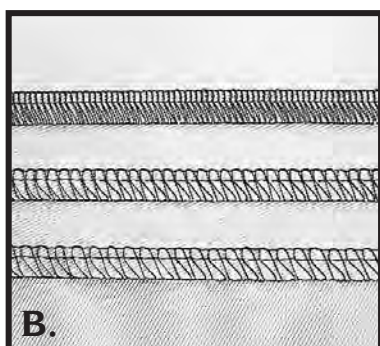
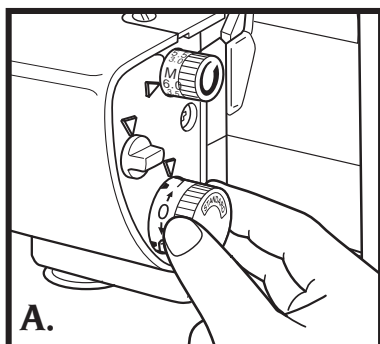

The stitch length / rolled hem adjusting dial is conveniently located just to the left of the front cover, near the base plate (fig. A). The dial shows two stitch-length ranges, each minimum from 0.75, for the shortest stitch, to 4 for the longest (fig.C). As the dial indicates, one range is for standard sewing and one is for rolled edging or narrow seaming. Simply turn the dial aligning the desired setting with the indicator the machine. A stitch length of 3mm, or about 10 stitches per inch is ideal for seaming and overedging most fabrics. For overedging or seaming very lightweight fabrics, (page 33) or for the rolled edge, you may prefer a shorter stitch length. When sewing heavier fabrics and using applications such as gathering, you may choose to lengthen the stitch (fig.B).

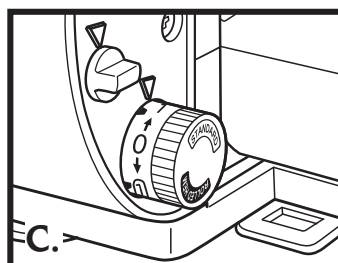

**Note:** 0.75mm is located between the 0 and 1 on both standard and rolled setting.

## Stitch Width

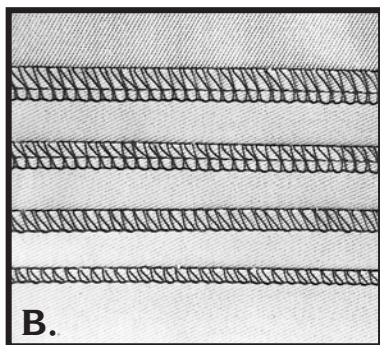
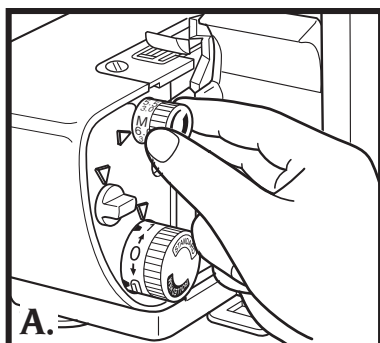

The stitch width adjusting dial is located above the stitch length dial (fig.A). The stitch width dial display two sets of numbers, indicating two width ranges. The larger numbers at each end of the dial, 5.5 and 7.5mm, denote the stitch width when the left-hand needle is in use. The smaller numbers, 3.0 and 5.0mm, apply when only the right-hand needle is in use for forming a 3-thread stitch. The “M” setting is for the rolled edge.

Adjusting the stitch width moves the upper cutting blade. It also moves the stitch fingers farther apart or closer together for complete fabric support with any stitch width.

The stitch width is infinitely variable between either end of the range. Simply turn the dial aligning the desired setting with the indicator on the machine. Use a wider stitch on loosely woven fabrics. You may prefer a narrower stitch on knitted, tightly woven or sheer fabric (fig.B)

## Differential Feed

Your Baby Lock serger is equipped with differential feed, meaning it has two sets of feed dogs, one in the front and one in the back. They can then work independently at different distances to ensure smooth serging on all fabrics (fig.A)

When the differential feed adjusting lever, located at the machine's right, front edge is set on "N" for normal feeding, the feed dogs move the same distance. This is the setting to use for most fabrics and applications (fig.B)

When the dial is set above "N", the front feed dog will feed more fabric than the back. This is because the front feed dog moves a greater distance than the back feed dogs. As a result, the fabric becomes compressed or eased, as the diagram on the front cover indicates. This action can eliminate wavy seams in stretchy fabrics or those cut on the bias grain.

The Baby Lock differential feed is a superior system for gathering. The bottom of the presser foot has a built-in fabric escape. It appears to be a half circle cut out which allows the fabric to gather without interference from the foot. At the maximum setting of 2.00 (fig.C), the differential feed can gather a lightweight fabric to nearly double fullness (fig.D). The front feed dog is actually feeding in twice as much fabric as the back feed dog is feeding out. To maximize the gathering effects, use the longest stitch length setting. Fabric weight will affect the gathering ratio. Test stitch for desired results.

When the differential feed lever is set below "N", the front feed dog moves less distance than the back feed dog (fig.E) This adjustment stretches the fabric slightly as it is sewn, pulling it taut as it enters the needle (fig.F) These lower settings prevent puckers on lightweight fabrics, add more stretch to swim and active wear and can be used to create a lettuce edge (page 33).

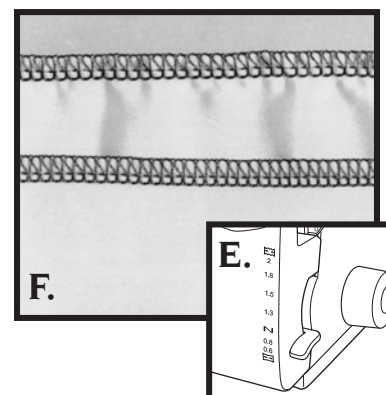
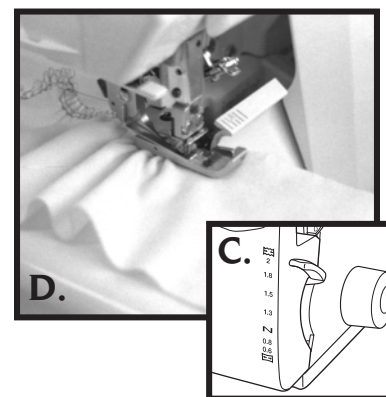
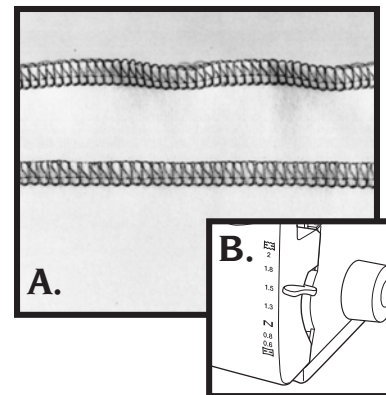



## Disengaging the Upper Cutting Blade

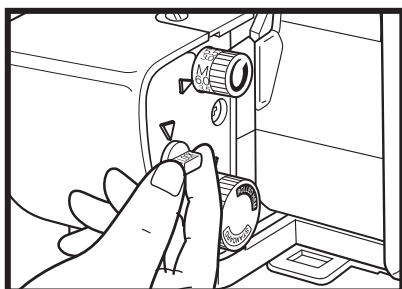

When no trimming is desired, as when stitching on a fold, flip the cutting blade lock switch clockwise to the LOCK position. The cutting blade no longer moves up and down, but remains in its lowered position.

## Presser Foot Pressure

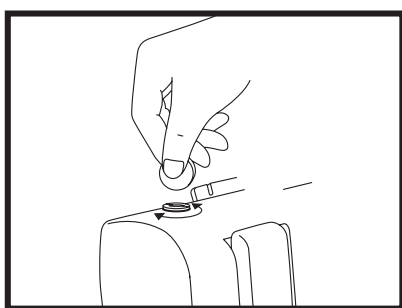

The presser foot pressure has been preset at the factory and rarely needs adjustment. You may find it necessary, however, to decrease the pressure for thick fabrics or increase pressure for thin fabrics to feed more smoothly under the foot. To increase pressure, turn the pressure adjusting screw clockwise; to release pressure, turn the screw counterclockwise.

## Snap-On Presser Foot

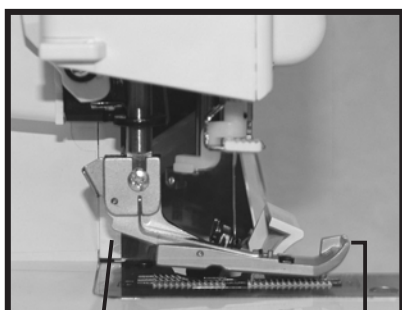

Presser Foot  
Release Button

Seam Line  
Guides

The Eclipse has the convenience of a snap-on presser foot.

### To Release:

1. Raise the presser foot lever.
2. Lower the cutting blade.
3. Raise the needles to the highest position.
4. Push the presser foot release lever located at the back of the presser foot holder.
5. Carefully turn the presser foot clockwise 90 degrees.
6. Slide the presser foot to the rear to remove.

### To Replace:

1. Raise the presser foot lever.
2. Lower the cutting blade.
3. Raise the needles to the lightest position.
4. Slide the foot from the left to right.
5. Align the bar of the foot with the groove in the holder.
6. Lower the presser foot lever to snap into place.

The presser foot that comes with the Eclipse has a tape sewing slot. Insert the tape or ribbon, into the slot in the front of the foot, then under the sole of the foot. (see page 23 for more instruction)

The raised markings on the toe of the foot are seam line guides. They indicate the needle positions to help guide your fabric for accurate seaming.



## Overedging

Overedging to finish facings, hems and seams before construction, is one of the most basic uses of a serger, such as making a garment or project with 5/8 inch (16mm) pressed open seams (fig.A).

To overedge, place the single layer of fabric in front of the presser foot, aligning the cut edge with upper cutting blade. Begin serging, continuing to guide the fabric along the blade. The edge of the fabric should be trimmed, but not cut away. Then sew the seams on your conventional sewing machine and press them open as usual (fig.B).

Because notches would be cut away in this process, mark them before serging with "V" snips just inside the seam allowance or with a water-soluble fabric marker (fig.C).

**Note:** A 2-thread overlock or 3-thread overlock can also be used with this technique.

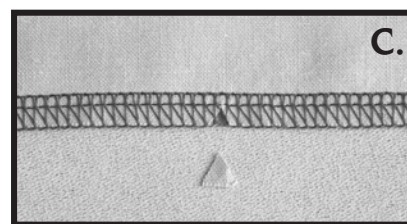
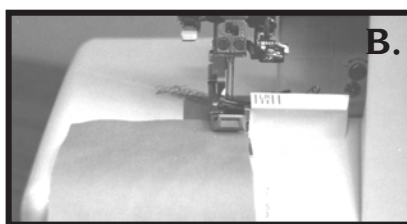
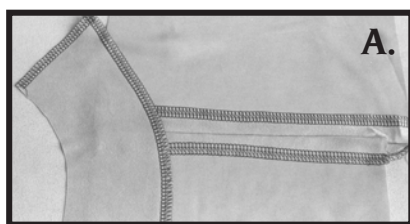

## Seaming

For garments or projects that do not require conventional pressed open seams, you can stitch and finish the seam in one operation and then press the seams to one side (fig.A). A 4 or 3-thread seam is strong, yet it provides "give" or flexibility according to the needs of the fabric.

Place two layers of fabric right sides together. Use the marks on your serger's front cover to align the fabric for the desired seam width. Keep your eye on the fabric edge to guide it to the appropriate mark (fig.B).

Do not watch the needle. If you guide the fabric accurately, the needle will seam in the correct place automatically.

**Note:** For most seaming, pins are unnecessary because the serger feeds the fabric evenly. If you need pins, place the pins parallel to the seam line outside the seam allowance to avoid damaging the blades.

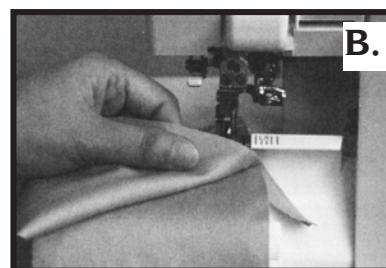
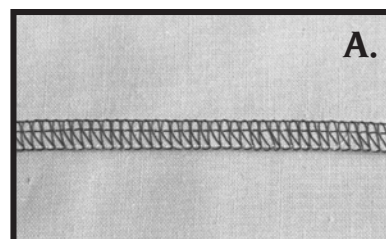

## Front Cover Seam Guide

Use the marks on your serger's front cover and set the width dial at "M" to align the fabric for accurate seam allowances. When using the left needle, the second mark "L" from the needle indicate 5/8 inch (16mm) from the cutting edge to the needle.

Use the right needle, the third mark "R" from the needle to indicate 5/8 inch (16mm) from the cutting edge to the needle.

**Note:** Be sure to set the width dial at the "M" setting for accurate seam allowances.

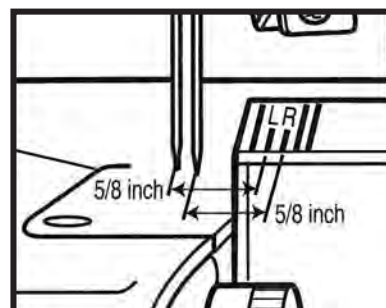

## Securing Ends

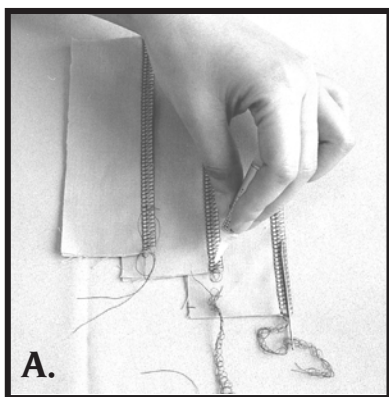

The serger stitch will not unravel readily, and in most cases serged seams are secured by an intersecting seam.

If that's not the case, these are several options for securing seam (fig.A)

1. Leave a 3 inch (7.5cm) chain, separate the threads and tie a knot.
2. Apply a dot of seam sealant on the thread chain at the fabric edge. Allow to dry and cut off the excess thread chain.
3. Leave a 3-4 inch (7.5-10cm) thread chain and use a large-eye tapestry needle or double-eye needle to weave the chain back into the stitching.
4. Lock the beginning or end of a seam by serging over the previous stitches.

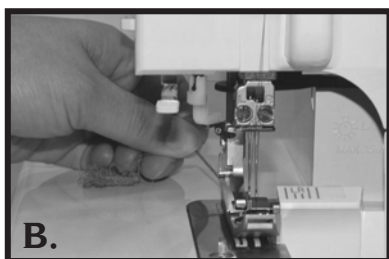

### To lock the beginning of the seam:

1. Manually turn the handwheel toward you taking 2-3 stitches into the fabric. Leave the needle(s) in the lowest position to anchor the fabric.
2. Raise the presser foot.
3. Smooth out the thread chain with your fingers (fig.B). Then bring the chain around and under the foot, so that it aligns with the edge of the fabric (fig.C).
4. Lower the foot and continue sewing, catching the thread chain in the stitches for about 1 inch (2.5cm). Let the blades cut off any remaining thread chain (fig.D-E).

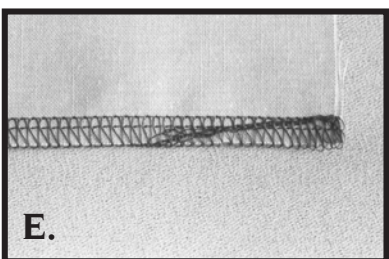
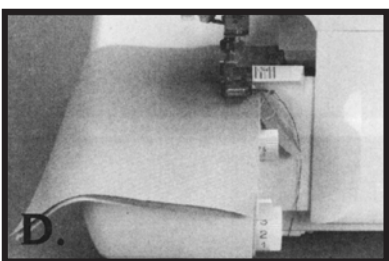
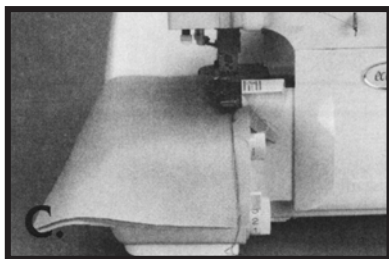

## Securing Ends (Cont.)

### To lock the end of the seam:

1. Take one stitch off the end of the seam (fig.A).
2. Raise the presser foot and bring the needle(s) to the highest position. Pull back gently on the fabric to clear the stitch fingers.
3. Turn the fabric over with the wrong side of the stitch facing up (fig.B), and reposition it under the presser foot with the needle at the seam edge, aligned with the previous needle line (fig.C).
4. Lower presser foot and sew 5-6 stitches over the previous stitches being careful not to cut them. You may want to flip the cutting blade lock switch clockwise to the lock position. Pivot the fabric and chain off (fig.D-E).

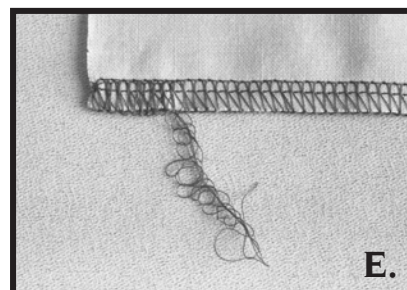
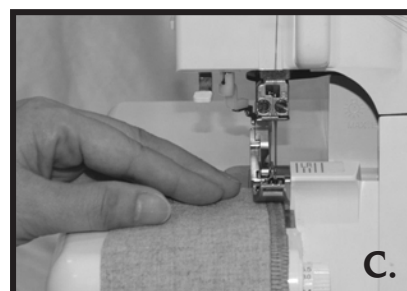
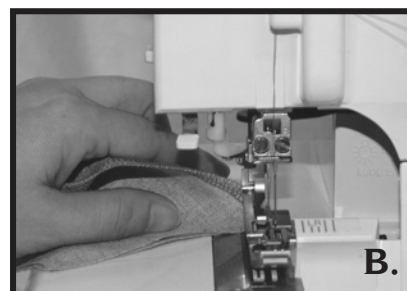
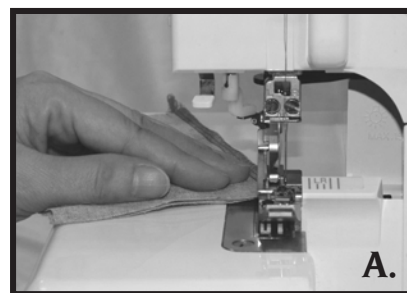

## Turning Outside Corners

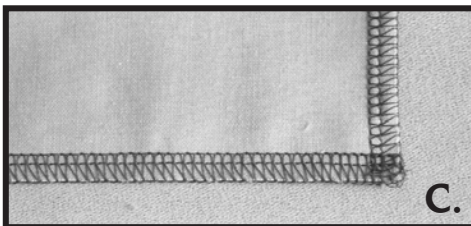
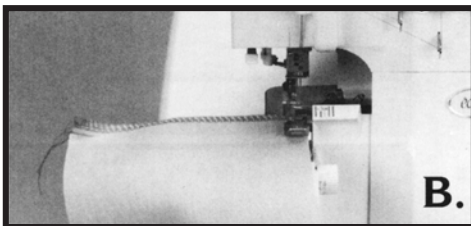
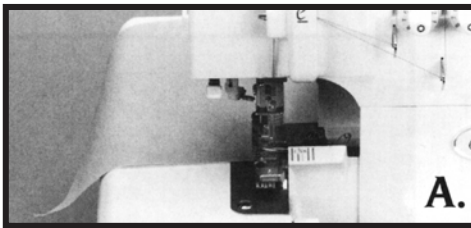

1. Stitch along one edge until you reach the corner. Take one stitch off the edge of the fabric (fig.A). (As you approach the edge, you may want to stop and manually turn the handwheel towards you.)
2. Raise the needle(s) to the highest position.
3. Clear the stitch fingers, and rotate the fabric to reposition the needle at the previous row of stitching (fig.B). Gently pull up on all threads to remove slack and resume stitching (fig.C).

**Note:** A loose thread loop at the corner is caused by too much slack in the needle thread when clearing the stitch fingers. Try again; turning corners takes a little practice!

## Turning Inside Corners

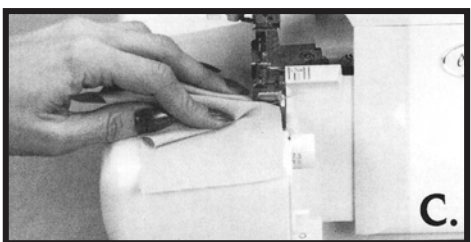
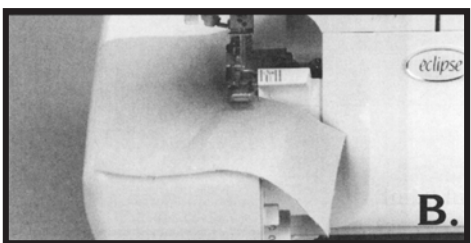
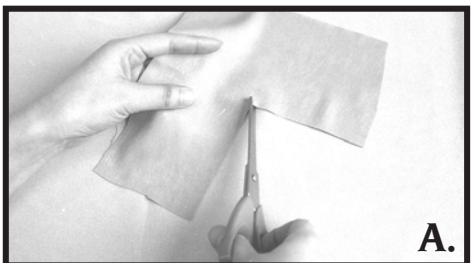

1. Reinforce loosely woven fabrics at the corner with staystitching on the conventional sewing machine. Clip to the corner (fig.A)
2. Align the fabric edge with the blade, and stitch until the blade reaches the corner, not the needles. Don't cut into the corner (fig.B)
3. Lower the needle(s) to anchor the fabric.
4. Raise the presser foot and straighten out the fabric, forming a pleat at the corner (fig.C)
5. Be sure the marked stitching line is straight, then continue serging the remaining edge. When done correctly, the pleat will disappear after stitching (fig.D)

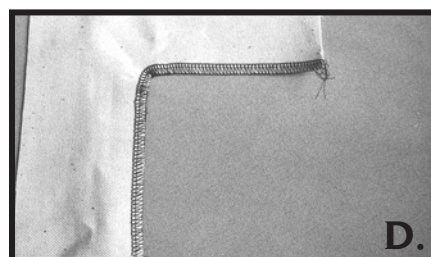



## ***Serging Curves***

To serge around inside or outside curves, guide the fabric into the blade, not the needle. Remember, cutting takes place before the fabric reaches the needle. Because the long serger presser foot holds the fabric more securely, you may need to raise and lower the presser foot several times to maneuver around very tight curves.

## ***Inserting Tapes***

The tape-sewing slot in the presser foot is designed to guide a stabilizing tape, narrow elastic or decorative ribbon into the stitching. Insert the tape or elastic into the slot and under the back of the foot (fig.A) Adjust the stitch width to match the tape width. Place the fabric under the foot and stitch (fig.B).

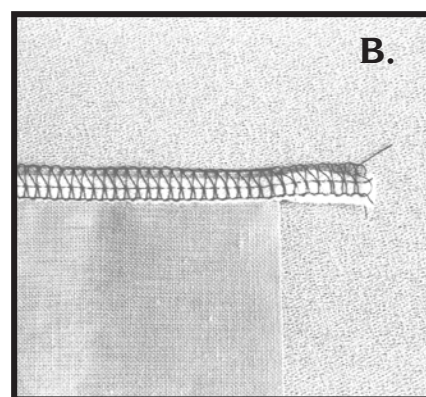
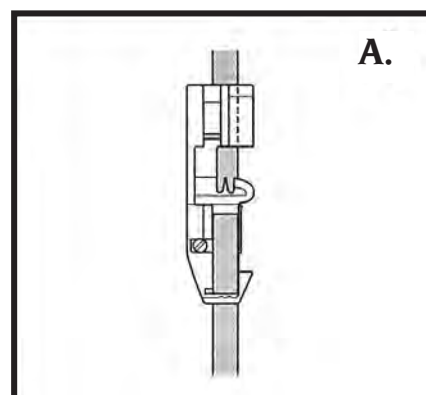

## 4-Thread Serging

Your Baby Lock Eclipse comes to you set for 4-thread serging, which provides a very durable, yet fully stretchable, seam or edge finish on all kinds of fabrics. With tensions properly set, the upper and lower looper threads lock together evenly over the cut fabric edge(s) to form a flat, non-rolling pattern of overlocking stitches on both sides of the fabric.

The left needle thread interlocks with both looper threads at the stitching line to create the seam. The right needle thread, visible on the top side of the stitch, interlocks with both loopers to add durability. The upper looper thread, that resembles a zig zag, on the upper side of the fabric, is from the upper looper that moves up above the throat plate and down. The lower looper thread, that resembles a zig zag on the lower side of the fabric, is from the lower looper that only moves lower than the throat plate.

The tension on each thread is controlled by its own tension dial. Turn the dial to a higher number to tighten or increase the tension; turn it to a lower number to loosen or decrease tension. The chart on the inside back cover indicates the suggested number ranges for 4-thread stitching. On this chart, record specific settings for your own machine.

Various threads and individual preferences may require slight adjustment to the needle thread tension as well. Always sew a test sample to determine if the desired result is achieved. Refer to the diagrams for tension guidelines.

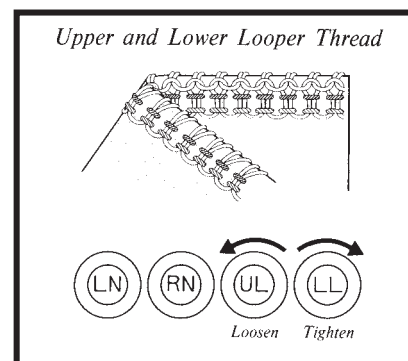
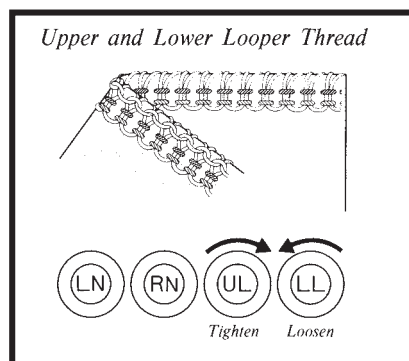
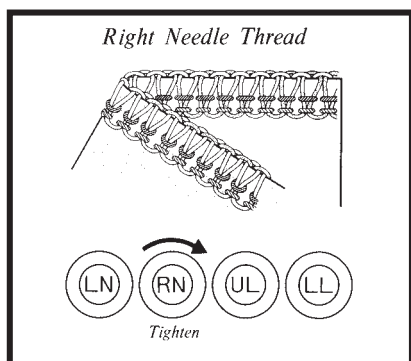
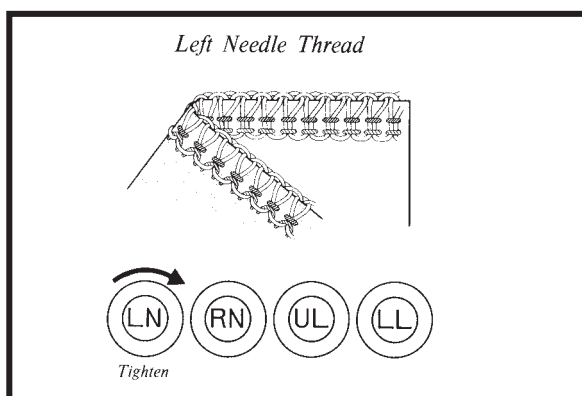
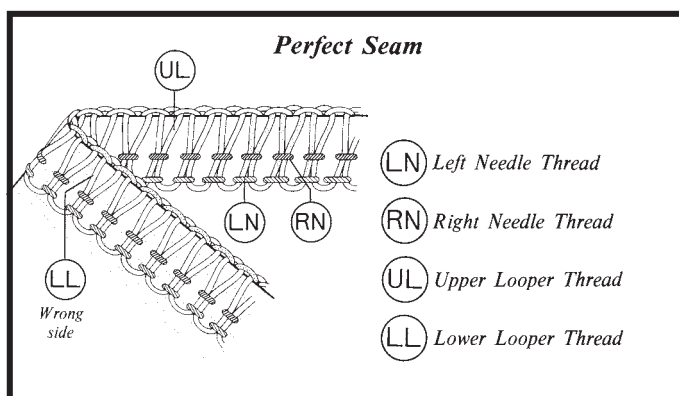



# 3-Thread Serging

3-thread serging works well - and conserves thread - for edge-finishing most wovens and for seaming knits that don't require the extra durability that a fourth thread provides.

It's easy to convert your Eclipse to serge with 3 threads by simply eliminating either needle.

To convert your serger to wide 3-thread stitching (5.5-7.5 mm), snip the right-hand needle thread just above the needle eye (fig.A). To convert to narrow 3-thread stitching (3.0-5.0mm), snip the left-hand needle thread. Remove the needle not being used, completely from the machine. Retighten the needle clamp screw slightly to prevent the screw from vibrating out (fig.B).

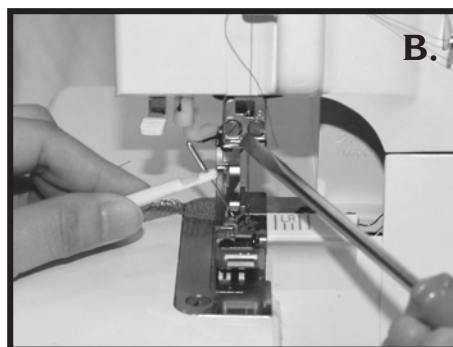
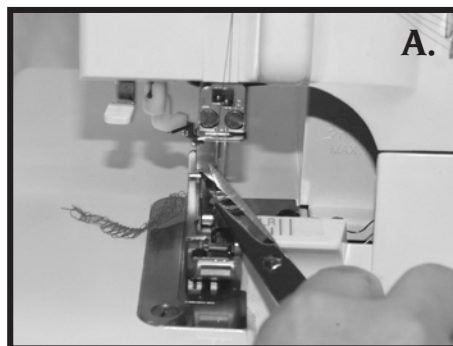

The tension on each thread is controlled by its own tension dial. Turn the dial to a larger number to tighten or increase tension, to a lower number to loosen or decrease tension. The chart on the inside back cover suggests tension ranges for 3-thread stitching. On this chart, record specific settings for your own machine.

Refer to the diagram to see what a balanced 3-thread stitch should look like. The other diagrams show unbalanced stitches and the tension adjustments necessary to correct them.

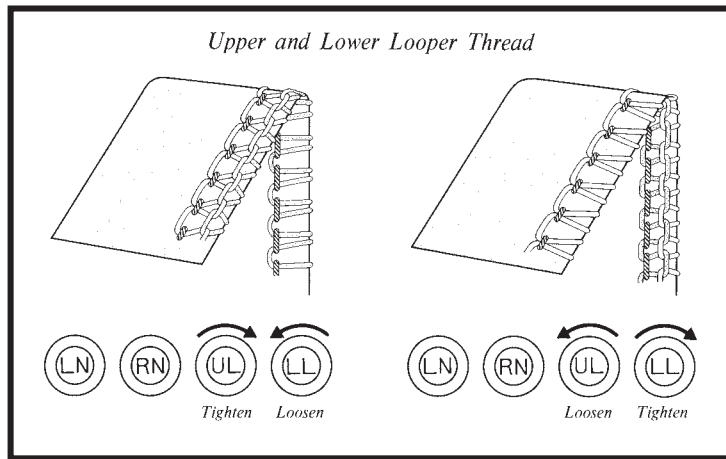
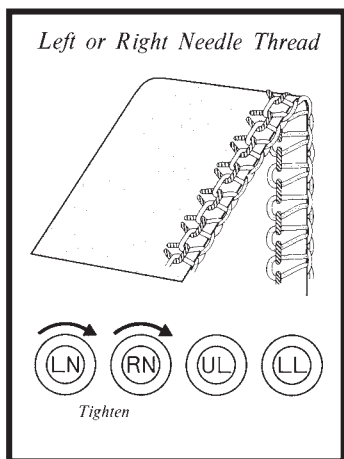
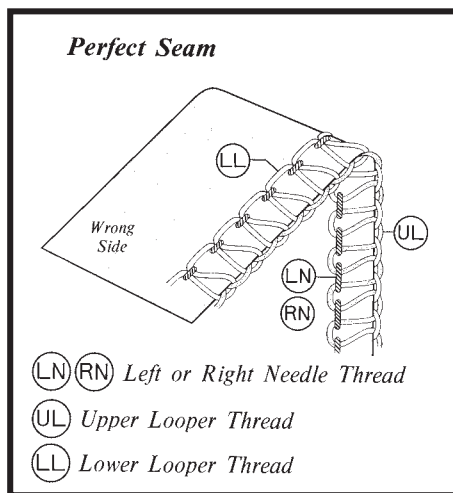

## 2-Thread Serging

The 2-thread function provides an economical and less bulky means of overedging all fabrics. When joining two fabrics together with 2-thread, the seam it forms is not a standard overlock seam but a *flatlock* seam. 2-thread rolled edge creates a delicate finish on fine wovens and smooth silkies. When sewn with specialty threads, 2-thread serging makes decorative seams and edges for activewear, children's clothing, ruffles and hemlines.

### Converting from 3-Thread to 2-Thread Serging

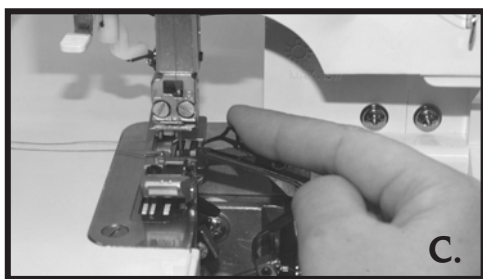
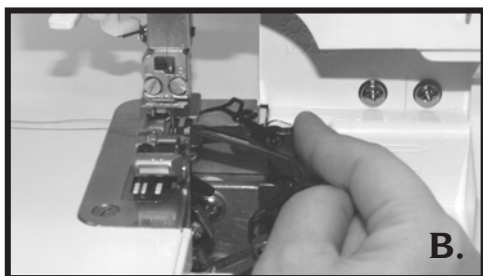
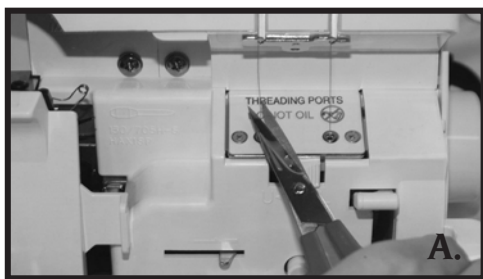

Either needle thread may be engaged for 2-thread serging.

1. Open the front cover and cut the upper looper thread just above the threading port (fig.A) Raise the presser foot and pull out the clipped thread from under the foot. Remove the upper looper thread from the machine.
2. Rotate the handwheel to bring the upper looper to its lowest position.
3. Rotate the subsidiary looper up and to the left (fig.B)\* then slip the end into the upper looper eye (fig.C)\*. Close the front cover.
4. Close the front cover, decrease the needle tension for 2-thread serging (see chart on the inside back cover). The needle and lower looper threads should overcast evenly on the cut edge of the fabric. Sew a test sample. Make adjustments if needed. Refer to diagrams.

\*The cutting blade cover has been removed in photos B and C for a clear view. You do not need to remove the cutting blade cover.

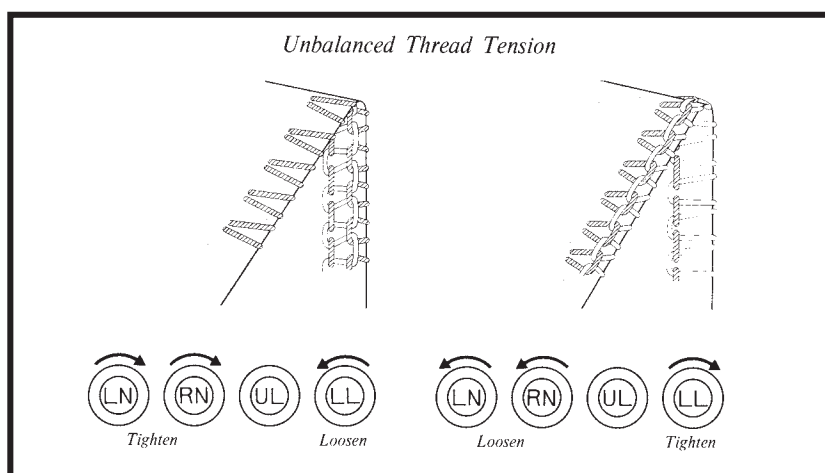
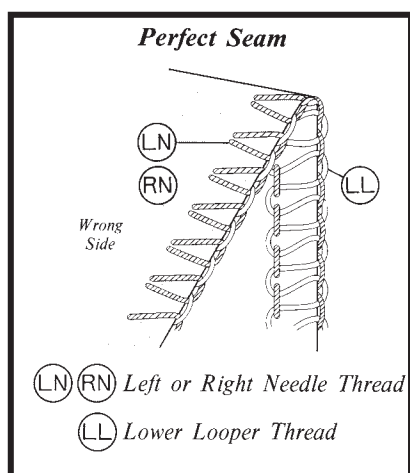

## Flatlock Seams

Flatlock seams are most suited to fabrics which do not ravel — interlock knits, tricot, sweatshirt fleece and synthetic suede. The serged edges pull open and flatten within the stitch for a non-bulky join (fig.A). Be sure to sew a test sample first to determine whether the stitch will have the strength to hold the seam without the fabric pulling away.

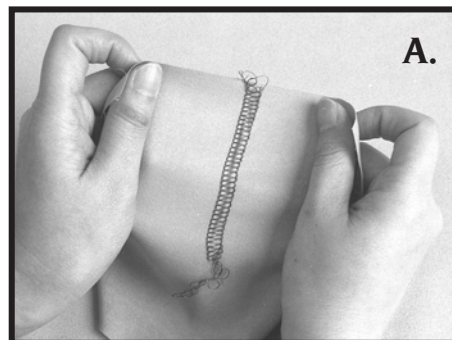

Sew flatlock seams in the same way as 3-thread seams, but then pull the two fabric layers apart until the seam lies flat. Because the threads show on the outside as well as the inside of the garment or project (except fake furs), the flatlock seam is often considered a decorative application (fig.B)

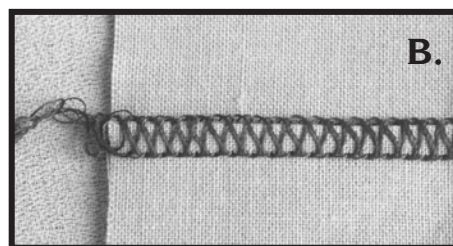

Before sewing, decide which stitch pattern you want to have on the outside of the garment. For “loops” (lower looper thread) to show, place fabric *wrong* sides together for sewing the seam (fig.C)

To produce the “ladder” (needle thread) on the outside, place the fabric *right* sides together (fig.D)

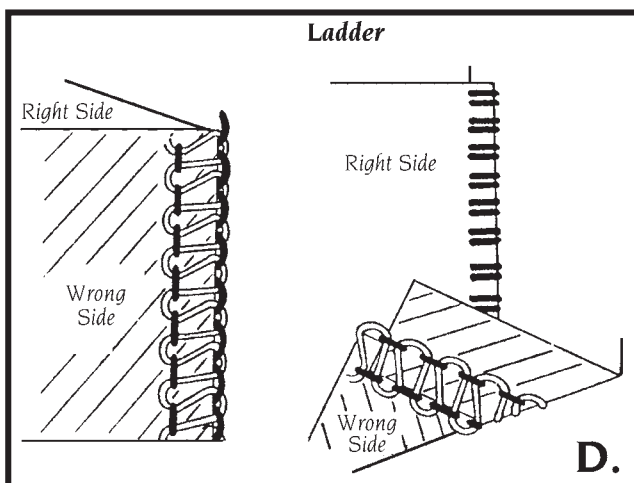
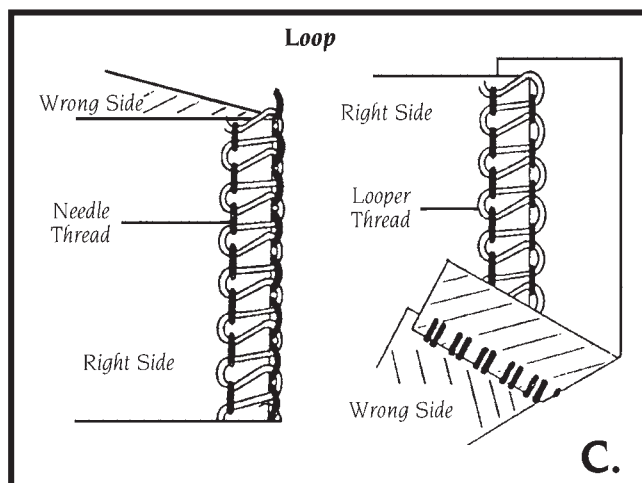

## Flatlock “Topstitching”

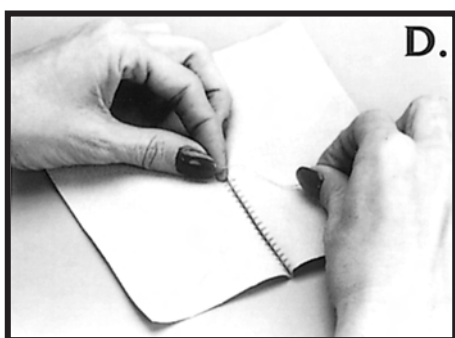
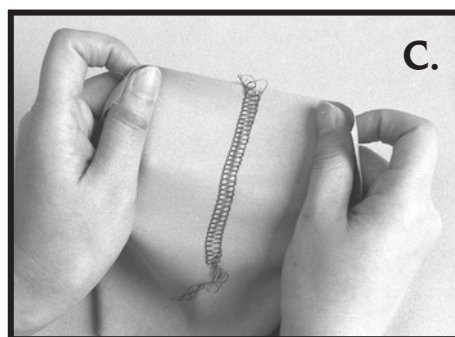
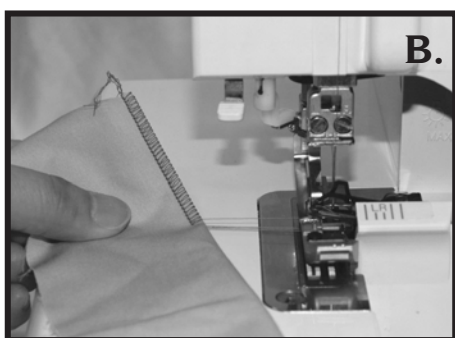
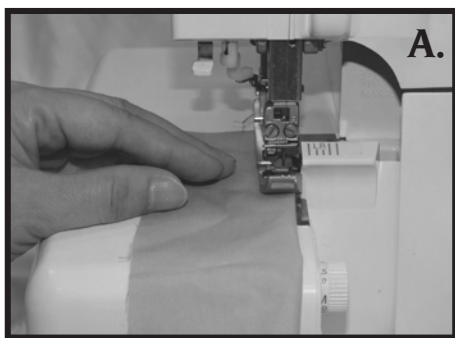

The flatlock stitch need not be limited at seamlines.

When sewn on a fold, flatlocking can create attractive decorative effects within the body of a garment or project. Either follow placement lines on your pattern or design your own special effects by stitching the fabric before laying out pattern pieces.

1. Set the machine for 2-thread flatlock-wide.
2. Turn the cutting blade lock switch clockwise to disengage the upper cutting blade.
3. Set the stitch length to desired setting.
4. Fold the fabric (right side or wrong side out, depending on the loop or ladder stitch you want to show) along stitch placement lines.
5. Position the fabric under the presser foot, aligning the fold of the fabric 1/8 inch (3.5cm) to the left of the upper cutting blade (fig.A).
6. Stitch to the desired ending point.
7. Clear the stitch fingers and chain off the fabric (fig.B).
8. Clip thread, leaving a 3-4 inch (7.5-10cm) chain.
9. Gently pull the fabric to flatten the stitches (fig.C).
10. Separate the chain threads and thread them through a needle and pull them to the fabric back side. If necessary, tie a knot to secure the threads (fig.D).

**Note:** If the fabric does not pull completely flat under the stitches, guide the fabric fold to the left so that the loops hang slightly off the fold as they are being stitched.

## Blind Hemming

Your Baby Lock Eclipse can create a sturdy, nearly invisible blindhem.

1. Set the machine for 2-thread serging with the right needle engaged. Set the stitch width at 5.0 and the stitch length at 4.0 in the standard range.
2. Fold up the hemline and press it in place. Then fold the hem allowance back against the fabric right side to create a soft fold about 1/4" from the top edge of the hem as shown (fig.A)
3. Align the fold under the presser foot and stitch, allowing the needle to catch only a thread or two of the soft fold; the blade will trim the top edge of the hem and the loopers will overcast the edge for a clean finish (fig.B)
4. Open the soft fold and press flat (fig.C)

**Note:** An optional blind hem foot for consistent guiding is available through your Baby Lock retailer (fig.D).

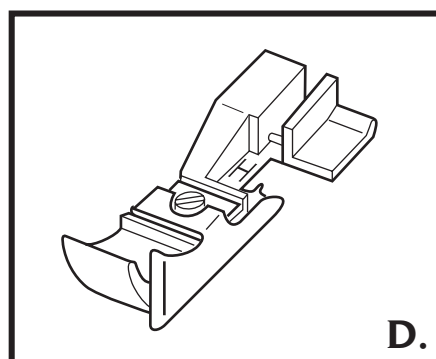
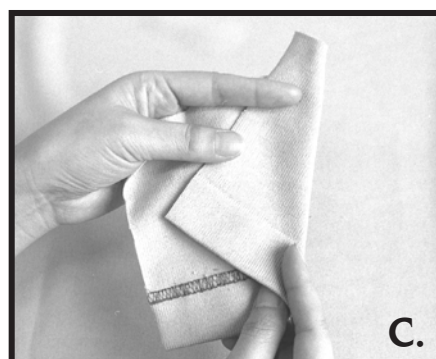
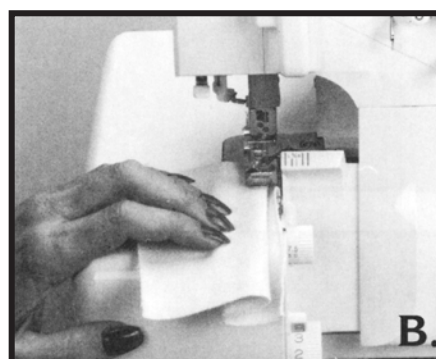



## Returning to 3 or 4-Thread Serging

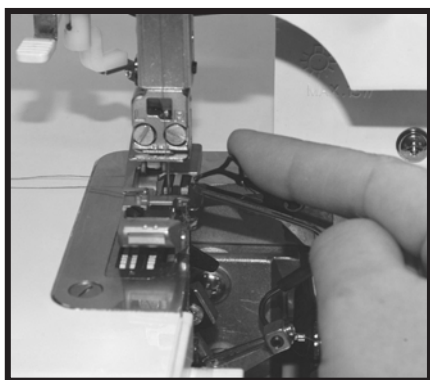

1. Open the front cover and rotate the handwheel forward to bring the upper looper to its lowest position.
2. With your index finger or tweezers, release the subsidiary looper from the eye of the upper looper. Rotate it further to the right until it snaps back into place and out of the way.
3. While holding the machine lock button down, rotate the handwheel forward until the button locks into place. Rethread the upper looper (page 11). For 4-thread serging, replace the second needle (page 40) and rethread it (pages 12/13).
4. Release the machine lock button with the lever and close the front cover.
5. Readjust tensions for 3-thread or 4-thread serging (see chart on inside back cover).
6. Lower the foot and sew a test stitch.



# Rolled Edging

The rolled edge setting is used to achieve the narrowest stitch possible (1.5 mm) on your Baby Lock serger. The stitch is suitable for seaming sheer and lightweight fabrics and for edging and hemming all but the heaviest fabrics.

## 3-Thread Rolled Edge

1. Remove the left needle and corresponding thread.
2. Clear the stitch fingers.
3. Turn the stitch length adjusting dial clockwise into the rolled hem range. Set the desired stitch length within this range (fig.A)
4. Turn the stitch width dial until the "M" lines up with the indicator (fig.B)
5. Increase the lower looper tension (fig.C)

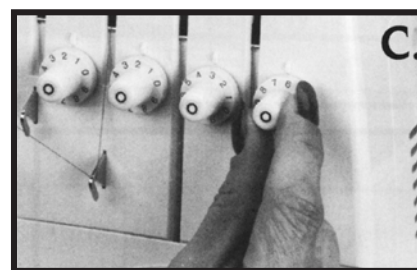
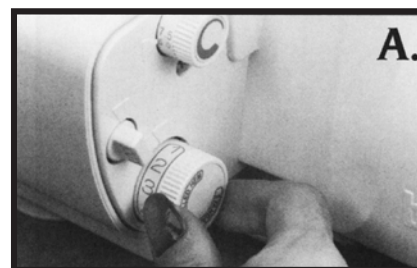

The tension adjustment tightens the lower looper thread, causing the fabric edge to roll around the stitch finger. The upper looper thread then wraps the fabric edge. The lower looper thread will be nearly invisible on the back side of the stitch formation. Sew a test sample first to determine if the fabric edge is sufficiently rolled. If not, increasing lower looper tension and decreasing upper looper tension both may help to create the desired effect. Record tension settings on the chart on the inside back cover.

**Note:** If a narrow *unrolled* edge is desired, follow step 1 thru 4 above, leaving tensions set as for standard 3-thread serging with the right needle.

RN Right Needle Thread    
 UL Upper Looper Thread    
 LL Lower Looper thread

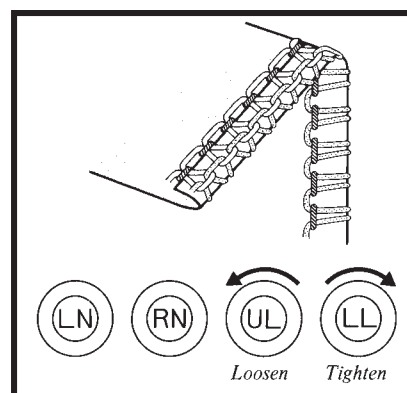
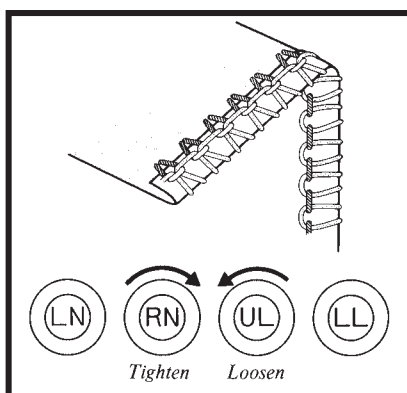
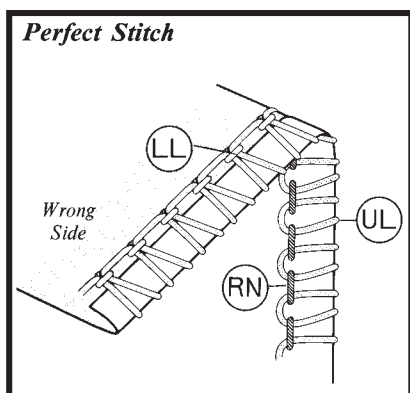

## Seaming Sheers

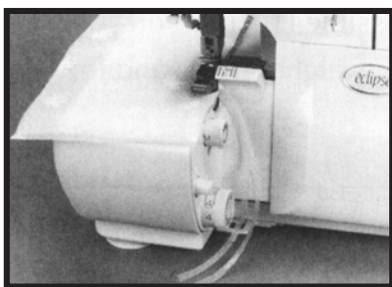

Use the 3-thread rolled hem setting when sewing sheer fabrics that otherwise would require French seams. Set the stitch length at 2 and adjust the tension for a rolled or unrolled edge as desired. Then simply sew the seams, aligning the fabric edges with the serger's seam guides, trimming away the excess seam allowance.

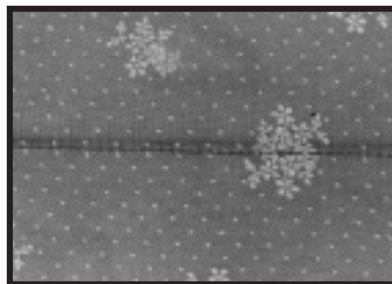

## 2-Thread Rolled Edge

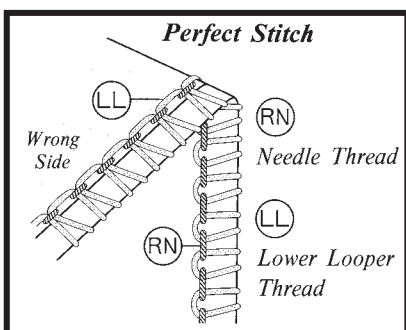

The 2-thread version of the rolled edge is often preferred for hemming very soft fabrics which might become too stiff if sewn with three threads.

1. Clear the stitch fingers and adjust the stitch width and length as for 3-thread rolled edge.
2. Set the machine for 2-thread serging (page 26), using the right-hand needle.
3. Adjust tension as shown in the chart on the inside back cover.

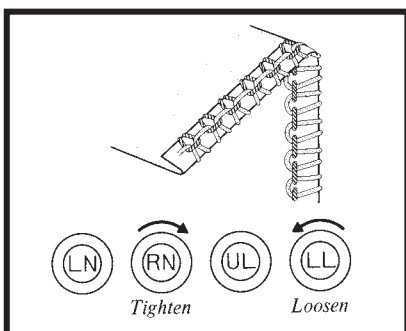

The tension adjustment causes the lower looper thread to roll around the stitch finger, wrapping the fabric edge. Sew a test sample. If the fabric edge is not sufficiently rolled, increase the needle tension and/or decrease the looper tension to help create the desired effect. Record your tension settings on the chart.

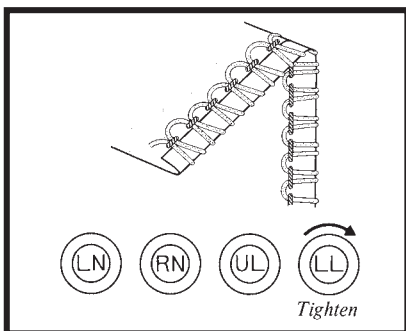

## Lettuce Edge

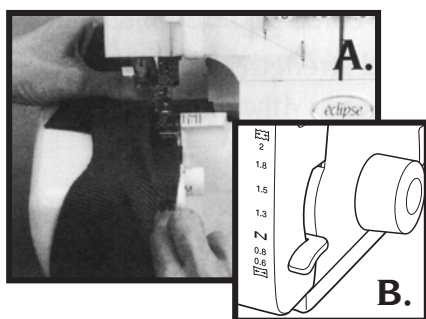

A frilly or “lettuce” edge can be created on most light and medium weight stretch fabrics and on bias edges of soft, woven fabrics. It makes a pretty decorative edging for activewear, lingerie, accessories and children’s wear.

Set the machine for the 2-thread or 3-thread rolled edge. Set differential feed at 0.6 (fig.B). Serge the fabric in the direction of greatest stretch - the crossgrain on knits, bias grain on wovens. For a “leafier” effect, try using a shorter stitch length and gently stretch the fabric (fig.A), as it is being sewn. Sew a test sample (fig.C)

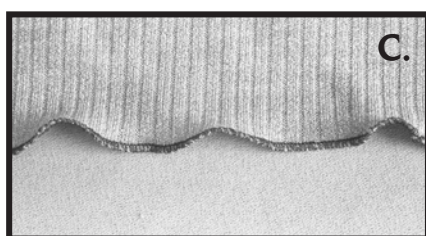

## Belt Loops and Button Loops

Use the rolled edge thread chain, stitched without fabric, to make professional belt loops and button loops. Using heavier decorative thread gives a stronger loop.



## Returning to Standard Serging

Clear the stitch fingers and return the stitch length dial to the standard range. Set stitch width and length at the desired settings. Readjust tensions. Replace the left-hand needle and its corresponding thread, if desired. To return to standard serging from the 2-thread rolled edge, also remove the subsidiary looper from the upper looper and replace its corresponding thread.

## Using Specialty Threads

Beautiful stitches can be formed by serging with specialty threads, cords and ribbons. These heavier or shinier threads can be used to enhance appearance, add strength or elasticity, or create special effects, depending on the thread you choose.

Some specialty threads work well through the needle and loopers, while others are too heavy to be threaded through the needle and are for looper use only. The thickness or coarseness of many of these threads requires loosening the tension disc that the specialty thread passes through.

Use the chart on (pages 38 / 39) as a guide in specialty thread use, keeping in mind that the quality of a kind of thread may vary from one manufacturer to another. Then, as you become more confident with serger sewing, experiment with additional threads and ideas.

## Threading Lightweight Thread

Specialty threads used in the needle can be threaded in the usual way. The ease with which they can be threaded in the loopers, however, depends on thread thickness.

**Lightweight thread**, including rayon machine-embroidery thread and nylon monofilament can easily be threaded on the Eclipse simply by tying them onto the existing serger thread.

## Changing Threads

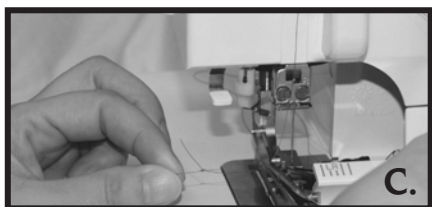
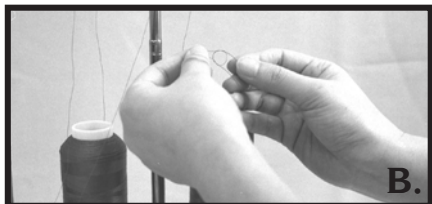
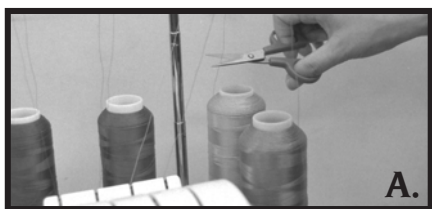

1. Clip the existing thread at the cone and remove the cone from the spindle (fig.A)
2. Place the new cone on the spindle. With the two threads together, tie an overhand knot, or square knot (fig.B)
3. Raise the presser foot, and pull the old thread from under the foot until the new thread comes through the machine.

**Note:** When changing a needle thread, pull the thread through until it reaches the needle eye. Then clip off the knot (fig.C), and rethread the needle eye manually or with the needle threader.

## Threading Medium Weight Thread

**Medium weight thread**, including topstitching thread, Decor rayon and stretch nylon thread, are too bulky to form a knot that would fit through the threading port, but they can slip through the hole with the aid of a thread “cradle” made from regular serger thread.

### Thread Cradle

1. Open the front cover and raise the presser foot to release all tensions.
2. At the threading port, clip the looper thread to be replaced (fig.A). Pull the thread out from under the foot and out of the upper guides. Remove the cone.
3. With the machine lock button in the locked position (fig.B), set the looper threading switch to "U" or "L" according to which looper is to be threaded.
4. Place the specialty thread on the spindle. Thread it into the upper guides, leaving an 18" tail above the threading port (fig.C)
5. Cut a 24 inch strand of serger thread and fold it in half to make the thread cradle. Insert the loose ends of the thread cradle into the threading port about 1".
6. Holding onto the cradle loop with your left hand, depress the threading lever with your right hand (fig.D) just until the thread ends come out the looper eye.
7. Insert the specialty thread tail into the cradle loop (E), and pull the serger thread ends until the specialty thread comes through the looper eye (fig.F). Discard or set aside the thread cradle.
8. Run upper looper thread under the foot and to the left, clip lower looper thread 4" and leave it hanging loose.

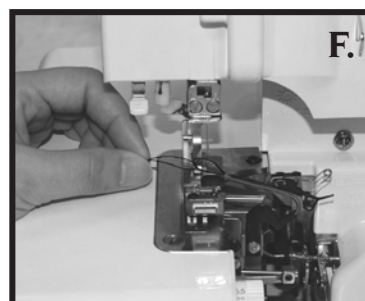
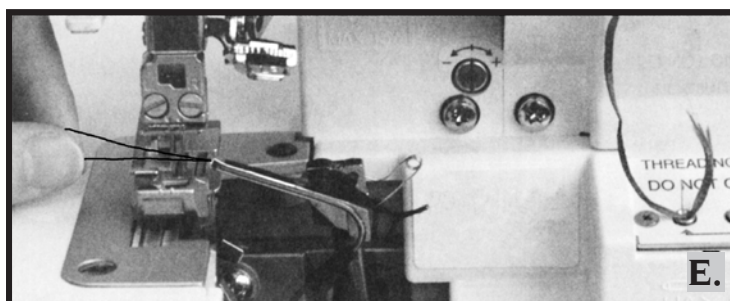
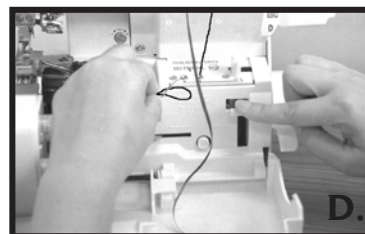
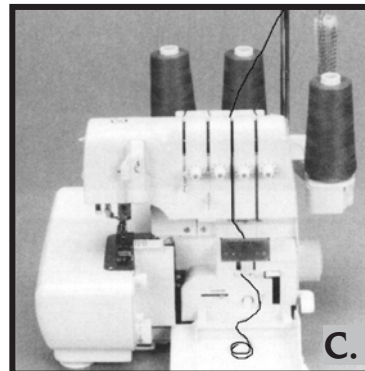
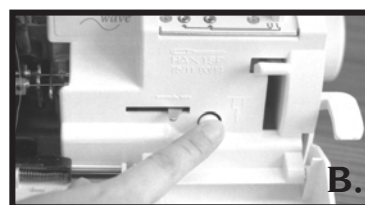



## Looper Threading Tool

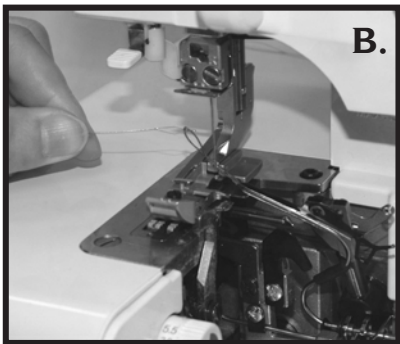

1. Open the front cover and raise the presser foot to release all tensions.
2. At the threading port, clip the looper thread to be replaced. Pull the thread out from under the foot and out of the upper guides. Remove the cone.
3. With the machine lock button in the locked position, set the looper threader selector to "U" or "L" according to which looper is to be threaded.
4. Place the specialty thread on the spindle. Thread it into the upper guides, leaving an 18" tail above the threading port.
5. Place the straight end of the looper threading tool into the threading port pushing it through until the end comes out of the looper eye.
6. Insert the loose end of the specialty thread into the looper threading tool eye (fig.A). Pull the straight end of the looper threading tool through the looper eye, the specialty thread will follow (fig.B).



## Bypassing the Threading Port

**Heavy weight thread**, such as pearl cotton, ribbon thread and fine yarn, must be tied onto the existing looper thread after bypassing the threading port, then pulled through the looper eye. Start with the machine threaded with regular serger thread.

1. Open front cover and raise the presser foot to release all tensions.
2. Just above the threading port, clip the looper thread to be replaced. Pull the thread out of the upper guides and remove the cone.
3. Place the specialty thread on the spindle. Thread it into the upper guides and clip it a couple of inches beyond the base plate (fig.A)
4. With machine lock button released, use the tweezers to pull the existing looper thread out of the tube extending from the threading mechanism (fig.B) Leave the thread in the looper arm itself.
5. Tie the specialty thread onto the regular thread with an overhand knot (fig.C). Pull on the regular thread from the looper eye until the specialty thread comes through the looper eye.
6. Place upper looper thread under the foot and to the left; clip lower looper thread at the base plate (fig.D)

If the thread is heavy and the overhand knot (step #5) is too large for the looper tube, follow directions #1 thru #6 on page 35 to make a thread cradle, Then:

1. Release machine lock button.
2. While holding the loose ends of the thread cradle with one hand, use the tweezers to pull the cradle loop out of the tube extending from the threading mechanism with the other hand.
3. Insert 2 inches of your decorative thread into the cradle loop. Pull on the loose ends of the thread cradle from the looper eye until the specialty thread comes through the looper eye.

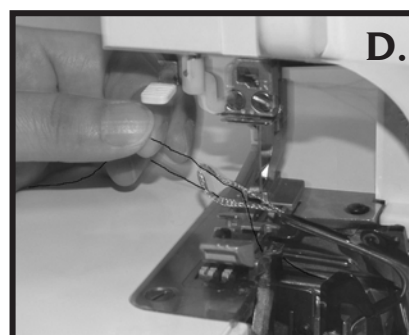
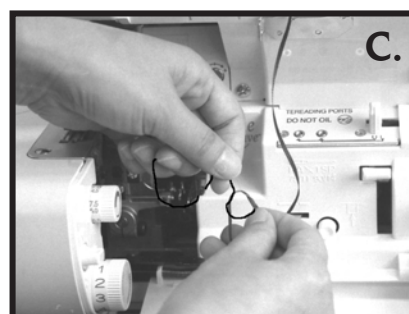
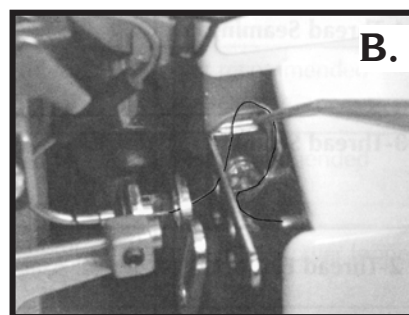
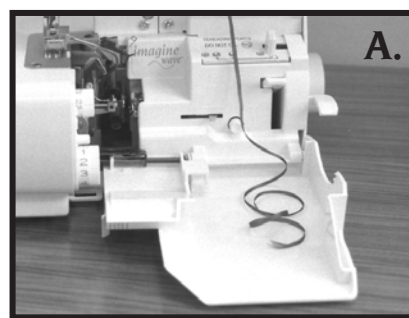

## Specialty Thread Guide Chart

	<b>Topstitching Buttonhole Twist</b>	<b>Stretch Nylon, such as Woolly Nylon</b>	<b>Fine Metallic Threads</b>
<b>APPLICATION</b>	Edging or flatlock seaming sportswear and home decor items.	Soft, stretchy seams on lingerie, swimwear, active wear, and for silky, rolled edges.	Highly decorative edges for sportswear, evening wear, holiday gifts and home decor.
<b>4-Thread Seaming</b>	Yes	Yes	Yes, for outside, exposed seams only.
<b>3-Thread Seaming</b>	Yes	Yes	Yes, for outside, exposed seams only.
<b>2-Thread Flatlock</b>	Yes	Yes	Yes
<b>4-Thread Edging</b>	Yes	Yes	Yes
<b>3-Thread Edging</b>	Yes	Yes	Yes
<b>2-Thread Edging</b>	Yes	Yes	Yes
<b>3-Thread Rolled Edge</b>	Use in upper looper only.	Yes	Use in upper looper only.
<b>2-Thread Rolled Edge</b>	Use in lower looper only.	Yes	Use in lower looper only.
<b>COMMENTS</b>	May work satisfactorily in size 90/14 needle, not in finer needles.	May be used in the needle. Tensions may require adjustment.	Varies greatly by manufacturer. Avoid those with coarse metal fibers. Experiment to find which works best.

# Specialty Thread Guide Chart

	<b>Clear Nylon Monofilament</b>	<b>Lingerie and Machine Embroidery Thread, such as Sulky Rayon</b>	<b>Silk or Rayon Topstitch Thread, such as Decor, and Metallic Yarn, such as Candlelight</b>	<b>Pearl Cotton Crochet Cotton 2-ply Baby Yarn Ribbon Thread</b>
<b>APPLICATION</b>	Items and applications requiring thread invisibility such as serger faggotting.	Lingerie and light-weight fabrics where stress on seams is not a factor; edging soft fabrics.	High-luster edging or flatlock seaming for elegant fashions, accessories and home decor items.	Edging or flatlock seaming for special decorative effects.
<b>4-Thread Seaming</b>	Yes	Yes	Not appropriate.	Not appropriate.
<b>3-Thread Seaming</b>	Yes	Yes	Not appropriate.	Not appropriate.
<b>2-Thread Flatlock</b>	Use in needle only	Yes	Use in looper only.	Use in looper only.
<b>4-Thread Edging</b>	Yes	Yes	Use in looper(s) only.	Use in looper(s) only.
<b>3-Thread Edging</b>	Yes	Yes	Use in looper(s) only.	Use in looper(s) only.
<b>2-Thread Edging</b>	Yes	Yes	Use in lower looper only.	Use in lower looper only.
<b>3-Thread Rolled Edge</b>	Yes, soft, light-weight monofilaments only.	Use in needle and upper looper. May break into upper looper.	Use in upper looper only.	Not appropriate.
<b>2-Thread Rolled Edge</b>	Yes, soft, light-weight monofilaments only.	Use in looper only.	Use in lower looper only.	Not appropriate.
<b>COMMENTS</b>	Some brands are too heavy and wiry to loop well. Look for lightweight, supple threads.	Use thread nets to prevent spilling off the bottom of the spool.	Require testing to achieve tension balance. Use metallic yarn in looper(s) only, bypassing the threading port to thread into machine.	Require testing to achieve tension balance. Use in looper(s) only, bypassing the threading port to thread into machine.

## Replacing Needles

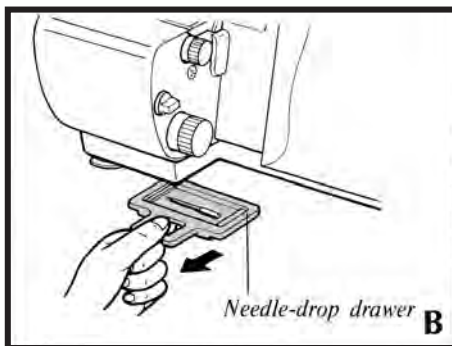
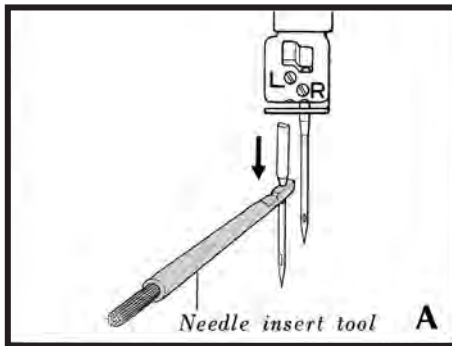

1. Raise the needle to the highest position by turning the handwheel toward you.
2. Using the small screwdriver, loosen the needle clamp screw and remove the needle.

**Note:** To prevent the needle from falling into the needle plate, hold it with the needle insert tool as you loosen the screw (fig.A).

3. Use the needle insert tool or tweezers to insert the new needle with the flat side to the back. Raise the needle as far as it will go, checking the position in the needle height viewing area.
4. Tighten the needle clamp screw.

**Note:** If you do drop the needle down into the machine, just pull out the needle-drop drawer at the bottom of your serger. The needle will be on the drawer (fig.B)

## Replacing Cutting Blades

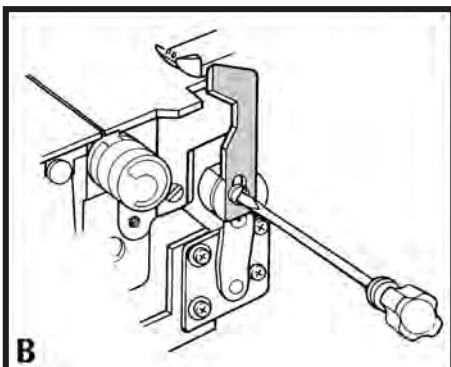
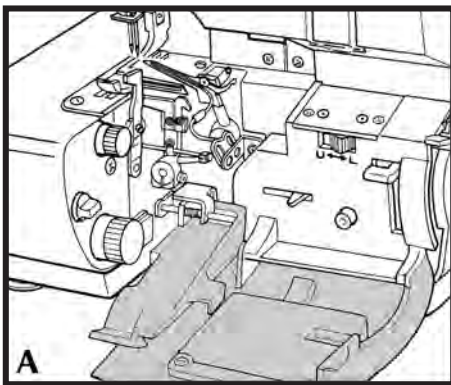

The lower blade, made of a special long-lasting steel, does not require frequent replacement. Your dealer can replace it for you when the time comes. The upper blade, on the other hand, is made of softer steel and will require replacing periodically, especially if you serge often with synthetic fabrics. You can replace this blade yourself; a spare upper blade is in the accessory compartment. If your machine is not cutting well, however, take it to your dealer first. Poor cutting action may be signaling another problem.

### **To replace the upper blade:**

1. Open front cover and cutting blade cover (fig.A)
2. Remove the screw holding the upper blade in place. Remove the blade itself (fig.B)
3. Position the new blade in the blade slot. Replace the screw. As you tighten the screw, hold the blade up in its highest position.
4. Close blade cover. Close front cover.

## Cleaning

Your Baby Lock will operate at best performance if it is kept clean at all times. The serger's cutting action creates much more lint than you will find on the conventional sewing machine. This lint impedes the machine's efficiency and acts as a sponge to draw oil from it.

Your serger will not need oiling for many years because the major moving parts are made from oil-impregnated metal. Use the cleaning brush often during garment construction to keep lint off the blades, needles and feed dogs. Remove the blade cover (Photos A and B on page 40 - "Replacing the Cutting Blades".) and throat plate periodically to clean more thoroughly.

### **To remove your throat plate:**

1. Turn your stitch length to the rolled hem setting.
2. Flip the cutting blade lock switch to the LOCK position.
3. Release the snap-off presser foot.
4. Remove needles.
5. Turn your handwheel until the upper looper is in the far right position.
6. Remove the front screw of the throat plate with the screwdriver and the back screw with the allen wrench.
7. With your right hand, first raise the throat plate in front of the blade. Pull slightly to the right, then remove to the left.
8. Replace in reverse procedure.

## Replacing the Light Bulb

1. Turn the power "Off" and do not attempt to change the bulb until it has cooled down.
2. Open the front cover, loosen the cutting blade cover fixing screw (page 40) and remove the cutting blade cover.
3. Remove old bulb and insert a new one (15W/110V, or 15W/230V over 200 voltage country).

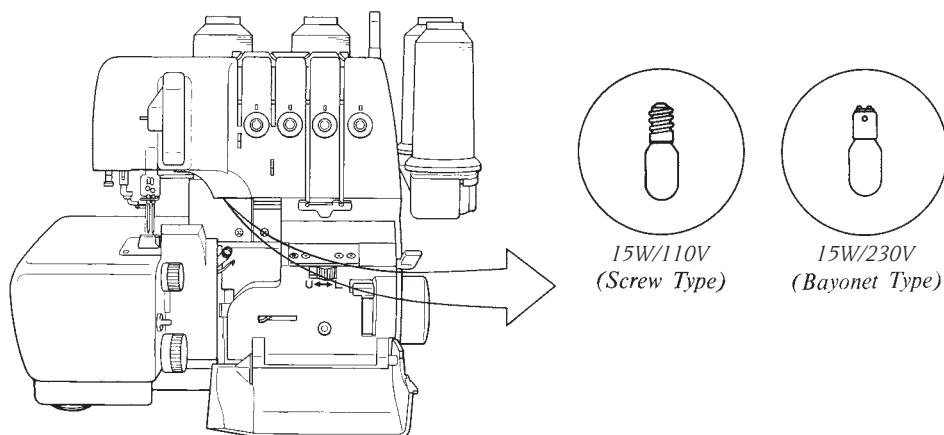

## Troubleshooting

Before taking your machine in for service, check the following:

### **Machine fails to start —**

1. Are electrical plugs properly connected?
2. Is the power switch on?
3. Check household circuit breaker or fuse.

### **Thread breaks —**

1. Is machine threaded correctly? Check each thread guide, all tension discs.
2. Is the needle inserted correctly?
3. Is the needle bent?
4. Is tension adjusted too tightly?
5. Is tension adjusted to accommodate thickness of thread being used?
6. Are you using inferior quality thread?
7. Is thread feeding off cone/spool freely?
8. Is the needle size correct for the type of fabric being used?
9. Are the needles being used, the correct Schmetz or Organ HAxISP system?

### **Skipped stitches —**

1. Is the needle bent or worn?
2. Is the needle inserted correctly?
3. Is the serger threaded correctly?
4. Is the presser foot pressure right for the fabric?

### **Fabric will not feed into machine —**

1. Is the machine lock button released?
2. Is the presser foot down?
3. Are the cutting blades sharp?
4. Are the cutting blades, presser foot and feed dogs free of lint?
5. Are the cutting blades properly set and is the upper blade against the lower blade?
6. Is the presser foot pressure right for the fabric?
7. Is stitch length set properly?

### **Stitch is unbalanced —**

1. Is the serger threaded correctly?
2. Is the needle tension too loose for the fabric being used?
3. Are the looper tensions properly adjusted?
4. Is the thread well seated in the tension disc?
5. Have you changed to specialty threads and not adjusted tension to accommodate a different thread thickness?



## ***Troubleshooting (Cont.)***

### **Needle threading difficulties —**

1. Is the needle threader selector at the appropriate setting? (“R” for right needle, “L” for left needle.)
2. Is the machine in the locked position for threading?

### **Looper threading difficulties —**

1. Is the looper threader selector at the appropriate setting? (Left threading port for “U” upper looper, right threading port for “L” lower looper.)
2. Is the thread end in the proper threading port?
3. Is at least 1” of the thread end in the threading port?
4. Is there at least 18” of loose thread beyond the thread guide above the threading port?
5. Is there a kink or twist in the 18” of thread to restrict the flow into the threading port?

### **Poor cutting —**

1. Are the cutting blades dull?
2. Have you sewn over a pin?
3. Is the cutting blade in the locked position?
4. Have the blades been improperly replaced?

## ***Dos and Don'ts***

1. Always be aware of the needle's up-and-down movement, and do not turn your attention from the machine while it is running.
2. When changing the needle, the presser foot or any other parts, always disconnect the machine by turning the power switch to OFF.
3. Do not place anything on the foot controller, or the machine will start inadvertently and the controller or motor can burn out.
4. The maximum permissible power for the light bulb is 15W/110V, or 15W/230V over 200 voltage country.
5. When using your serger for the first time, place a fabric scrap under the presser foot and run the machine without thread for a few minutes. Wipe away any oil that appears.
6. Do not pull fabric from the rear of the machine. Such action can damage the looper mechanism.
7. To prevent possible injury, always avoid body contact with any moving parts and the machine mechanism.
8. NEVER sew over pins.

**Special Caution:** Unplug the power cord from the electrical outlet when the machine is not in use.

## Technical Data

<b>Stitch Types:</b>	2 needles, 2 loopers: 4-thread overlock with integrated safety seam
	1 needle (left or right), 2 loopers: 3-thread overlock, flatlock, rolled edge with right needle only
	1 needle (left or right), 1 looper: 2-thread overedge, flatlock, rolled edge with right needle only
<b>Stitch Width:</b>	Standard 2/3/4-thread with left needle: 5.0-7.5 mm
	Standard 2/3/4-thread with right needle: 3.0-5.5 mm
	Rolled edge 2/3-thread with right needle: 3.5 mm
<b>Stitch Length</b>	Standard overlock: 1-4 mm Rolled edge: 0.75-4mm
<b>Differential Feed</b>	Gathering effect: N-2 Stretching effect: N-0.6
<b>Presser Foot</b>	Snap-on feet
<b>Handwheel</b>	Rotates forward
<b>Needle System</b>	ORGAN or SCHMETZ HA x ISP/CR
<b>Sewing Speed</b>	Up to 1500 s.p.m.
<b>Machine Weight</b>	7.3 kg/16 lbs.
<b>Light Bulb</b>	15W/110V or 15W/230V (Blue Bulb)

## Chart for Tension Adjustment

Stitch Type	Stitch Length	Stitch Width	L Needle Tension	R Needle Tension	Upper Looper	Lower Looper
<b>4-Thread Seam Overcasting</b>	2-3	5.0 - 7.5	4	4	4	4
	2.5 - 3.5	5.0 - 7.5	3.75	3.75	4	4
	3-4	5.0 - 7.5	3.5	3.5	4	4
<b>4-Thread Gathering</b>	4	5.0 - 7.5	4	4	4	4
<b>3-Thread Seam Overcasting Wide and Narrow</b>	2-3	3.0	N/A	4	3.5	3.5
	2-3	7.5	4	N/A	4	4
	2.5 - 3.5	3.0	N/A	3.75	3.5	3.5
	2.5 - 7.5	7.5	3.75	N/A	4	4
<b>3-Thread Rolled Edge</b>	0.75	M	N/A	3.5	3	7
	1.5	M	N/A	4	2.5	6.5
<b>2-Thread Flatlock</b>	2-3	3.5	N/A	1	N/A	5
	2-3	7.0	0	N/A	N/A	3.5
<b>2-Thread Rolled Edge</b>	0.75	M	N/A	4.5	N/A	3.5
	1.5	M	N/A	4	N/A	3.0

This chart indicates the suggested range of tension numbers for each stitch category. As you determine specific settings for your machine, record them on the chart in the blank spaces.

